

# CATALOGUE PIECES DETACHEES—DOCKER 2016



DATE	REVISIONS	COMMENTAIRES
05/07/2016	INDICE A	CREATEUR : Anne JOLLY

## CARROSSERIE

PARE CHOC AV .....	PLANCHE 20
CALANDRE.....	PLANCHE 30
CABINE AVANT.....	PLANCHE 40
CABINE .....	PLANCHE 50
JOINTS D'ETANCHEITE .....	PLANCHE 60
VUE ARRIERE.....	PLANCHE 70
PORTE GAUCHE.....	PLANCHE 80
PORTE DROITE .....	PLANCHE 90
CHASSIS + SUSPENSION .....	PLANCHE 100
VITRAGE.....	PLANCHE 110

## GROUPE MOTEUR

MOTEUR YANMAR.....	PLANCHE 120
MOTEUR LOMBARDINI .....	PLANCHE 121
ECHAPPEMENT POUR LOMBARDINI.....	PLANCHE 122
POULIE MOTRICE .....	PLANCHE 130
POULIE RECEPTRICE .....	PLANCHE 140
SYSTEME DE REFROIDISSEMENT .....	PLANCHE 150
SYSTEME DE REFROIDISSEMENT LOMBARDINI .....	PLANCHE 155
FILTRATION .....	PLANCHE 160
CHAUFFAGE .....	PLANCHE 170
RESERVOIR GASOIL .....	PLANCHE 180

## SYSTEME DE DIRECTION

SYSTEME DE DIRECTION .....	PLANCHE 200
----------------------------	-------------

## SYSTEME DE TRANSMISSION

BOITIER INVERSEUR.....	PLANCHE 220
ROUES.....	PLANCHE 230

## SYSTÈME DE FREINAGE

PEDALIER .....	PLANCHE 240
SYSTÈME DE FREINAGE .....	PLANCHE 250
FREINS AV G & D .....	PLANCHE 260
FREINS AR G & d.....	PLANCHE 270

## EQUIPEMENTS

HABILLAGE INTERIEUR .....	PLANCHE 280
SIEGES .....	PLANCHE 290
TABLEAU DE BORD .....	PLANCHE 300
CELLULE POLYESTER LONGUES ET PORTES .....	PLANCHE 310
CELLULE LISSE ET NON LISSE .....	PLANCHE 320
OPTIONS.....	PLANCHE 330

## FAISCEAUX ELECTRIQUES

BATTERIE + CABLAGE DE PUISSANCE + MGS .....	PLANCHE 340
FAISCEAUX HABITACLE.....	PLANCHE 350
FAISCEAUX PLAFONNIER .....	PLANCHE 360
FAISCEAUX PORTES GAUCHE ET DROITE .....	PLANCHE 370
CONDITIONS GENERALES DE VENTE .....	PLANCHE 380
FONCTIONNEMENT COMMANDE DE PIECES .....	PLANCHE 390
TARIFS PUBLICS ORDRE ALPHABETIQUE .....	PAGE 1-7

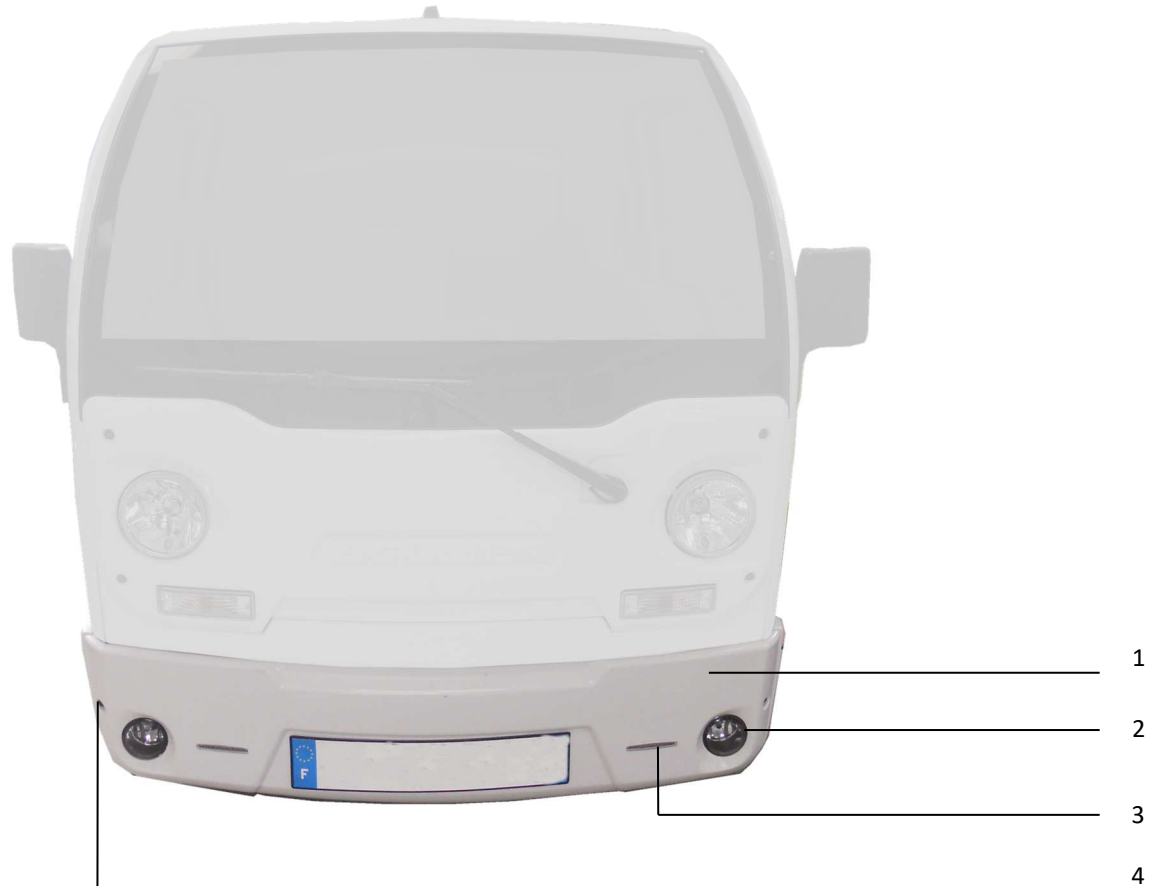
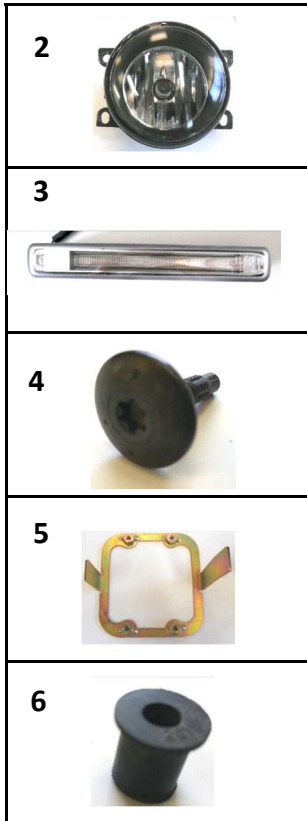



Repère	Q.TE	Référence	Désignation
1	1	00102448	PARE-CHOC
2	2	01453200	PHARE ANTIBROUILLARD
5	2	01453237	SUPPORT PHARE ANTIBROUILLARD
3	1	00453277	FEUX DIURNE (LA PAIRE)
4	2	00999963	VIS 6X20 TB TORX
6	2	00992903	WELL NUT

3



4



5



6



9



7



8



11



3

4

5









10



1

2

Repère	Q.TE	Référence	Désignation
1	1	00604904	JOINT L :1400mm
2	1	00102424	CALANDRE
3	4	00999963	VIS 6X20 TB TORX
4	2	00453256	PHARE
5	1	00453260	CLIGNOTANT AV G
10	1	00453261	CLIGNOTANT AV D
6	2	00452350	AMPOULE CLIGNOTANT AV
7	2	00353906	OBTURATEUR PHARE
8	1	00453200	PASSE-FIL OPTIQUE
9	1	00452349	FAISCEAU CLIGNOTANT
11	4	00992903	WELL NUT

- 1 
- 2 
- 3 
- 4 
- 5 
- 7 
- 8 
- 9 

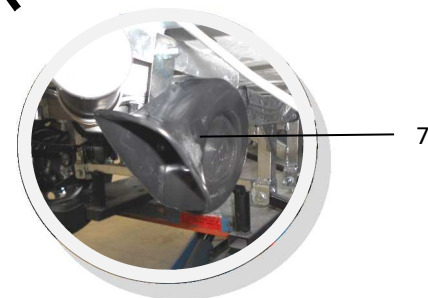
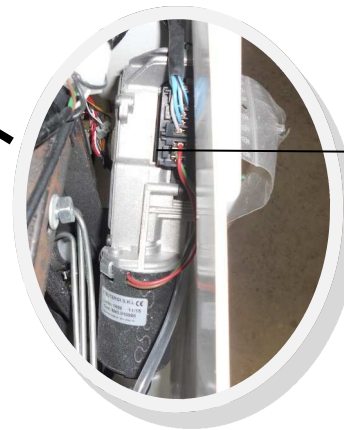

Repère	Q.TE	Référence	Désignation
1	2	00453254	PLATINE SUPPORT PHARE
2	2	00501620	EXTRACTEUR D'AIR
3	1	00451128	MOTEUR EG AV
4	1	00451126	BRAS EG AV
5	1	00451127	BALAI EG AV
6	1	00351100	RESERVOIR LAVE-GLACE & POMPE
7	1	00450807	AVERTISSEUR
8	1	00501101	PASSE-CLOISON LAVE-GLACE
9	1	00451132	CALE MOTEUR EG

	<b>40</b>	<b>CABINE AVANT</b>	<b>DOCKER</b>
-------------------------------------------------------------------------------------	-----------	---------------------	---------------



6

7



4



1



5



2

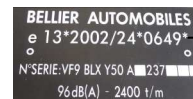

8



3











<b>Repère</b>	<b>Q.TE</b>	<b>Référence</b>	<b>Désignation</b>
1	1	00102925	CABINE BLANCHE ASSEMBLEE
2	1	00102921	ARCEAU G CABINE
3	1	00102922	ARCEAU D CABINE
4	2	00102912	PLAQUE FIXATION CABINE
5	1	00500131	DOIGT VERROUILLAGE SERRURE
6	2	00602904	PRESSE ETOUPE 40
7	1	00602902	PRESSE ETOUPE 50

	<b>50</b>	<b>CABINE</b>	<b>DOCKER</b>
-------------------------------------------------------------------------------------	-----------	---------------	---------------





Repère	Q.TE	Référence	Désignation
1	2	00600115	JOINT ETANCHEITE PORTE
2	1	00604904	JOINT PARE-BRISE L: 1100mm
3	2	00604904	JOINT PARE-BRISE L: 8000mm
4	1	00604904	JOINT L: 1400mm



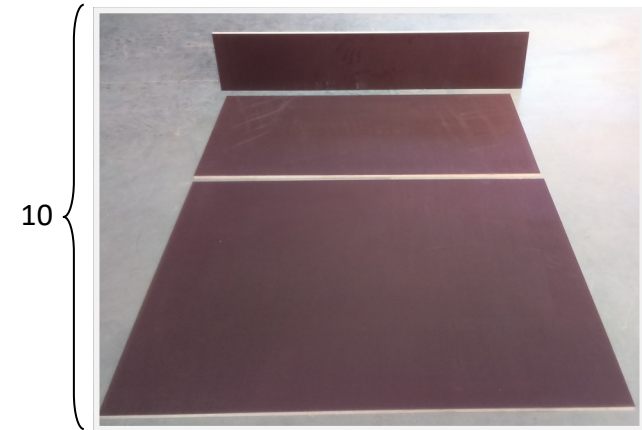
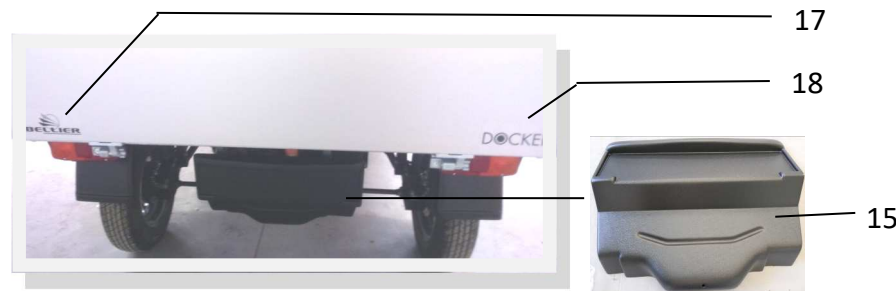





- 1 
- 2 
- 3 
- 4 
- 5 
- 6 
- 7 
- 8 
- 9 
- 21 











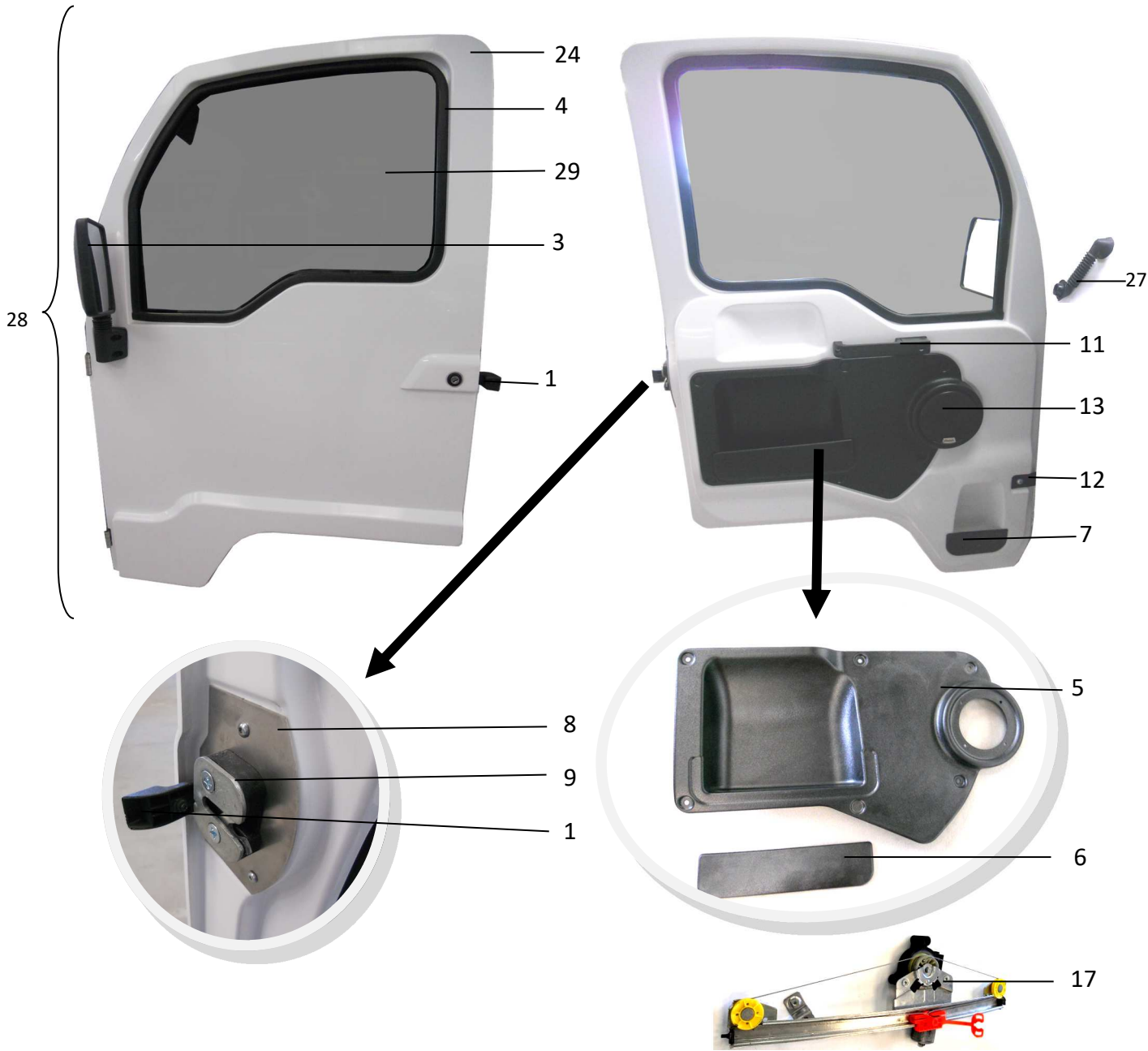

**BELLIER AUTOMOBILES**  
 e 13\*2002/24\*0649\*  
 N°SERIE: VF9 BLX Y50 A 237  
 96dB(A) - 2400 t/m

20

Repère	Q.TE	Référence	Désignation
1	2	00501621	CLAPET EXTRACTEUR D'AIR
2	1	01051705	VASE EXPANSION
4	1	00453242	FEU AR-D
3	1	00453243	FEU AR-G
5	2	00453238	AMPOULE CLIGNOTANT AR
6	2	01453221	AMPOULE FEU STOP & POSITION
7	1	00100213	GARDE-BOUE AR G
8	1	00100212	GARDE-BOUE AR D
9	1	00100211	EQUERRE FIXATION GARDE BOUE
10	1	00104704	PLANCHER BOIS LONG
11	1	00104510	RIDELLES ALU D
12	6	00104513	CHARNIERE RIDELLES ALU
13	1	00104511	RIDELLES ALU G
14	1	00104512	RIDELLES ALU AR
15	1	00102443	CARTER AR PROTECTION INF
16	1	00104703	PATTE FIXATION PLANCHER PARTIE
17	1	00754502	MONOGRAMME « BELLIER »
18	1	00754503	MONOGRAMME « DOCKER »
19	1	00104704	PLANCHER BOIS LONG
20	1	001001B6	PLAQUE CONSTRUCTEUR

- 1 
- 9 
- 11 
- 18 
- 19 
- 20 
- 21 
- 22 
- 23 



- 15 
- 14 
- 3 
- 8 
- 12 
- 26 
- 7 
- 13 
- 25 

Repère	Q.TE	Référence	Désignation
1	1	001001A3	BOUTON SERRURE G
3	1	001001B3	RETROVISEUR EXT G
4	1	00600116	JOINT COULISSE LECHEUR PORTE
5	1	00502969	GARNITURE PORTE G
6	1	00502971	BANDEAU VIDE POCHE G
7	1	00502973	BANDEAU PORTE-BOUTEILLE D&G
8	1	00100171	PLATINE FIXATION MECANISME
9	1	00100168	GACHE PORTE G
11	1	00500118	POIGNEE PORTE INT G
12	1	00100169	SANGLE ARRET PORTE
13	1	01450609	HAUT-PARLEUR (PAIRE)
14	1	00500127	BARILLET PORTE D&G
15	1	00100161	SERRURE PORTE G
17	1	01450103	LEVE-VITRE ELECTRIQUE G
18	1	00600102	JOINT GLISSIERE VITRE
19	1	00100300	COULISSE AR G
20	1	00500128	CLIP BARILLET PORTE
21	1	00100306	SUPPORT COULISSE AR G
22	1	00100134	CHARNIERE PORTE D&G
23	1	001001A6	TRINGLE PORTE
24	1	SEPORTENUEDOCKG	PORTE NUE G
25	1	00500129	LIAISON BARILLET PORTE
26	1	00100170	PLATINE FIXATION SANGLE
27	1	00502300	SOUFFLET PASSE-FAISCEAU
28	1	SEPORTEGDOCK2	PORTE COMPLETE G
29	1	01803705	GLACE PORTE G

- 1
- 9
- 11
- 18
- 19
- 20
- 21
- 22
- 23

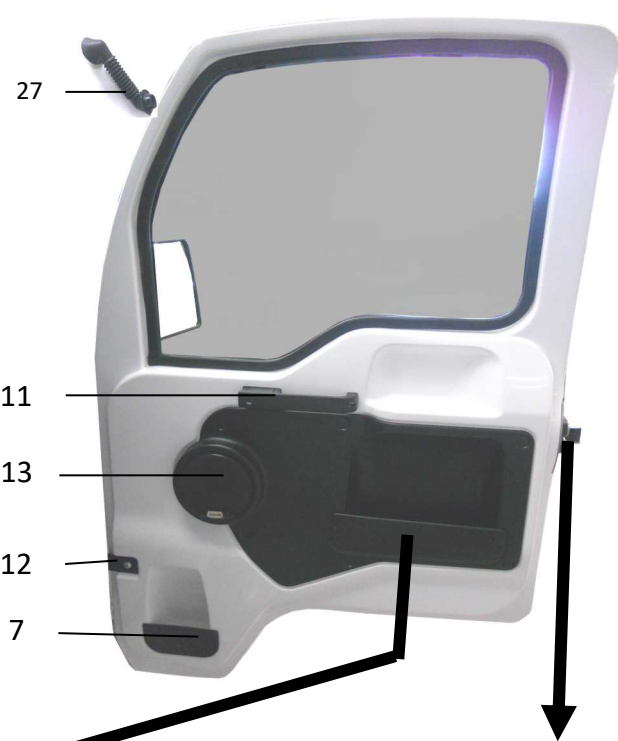
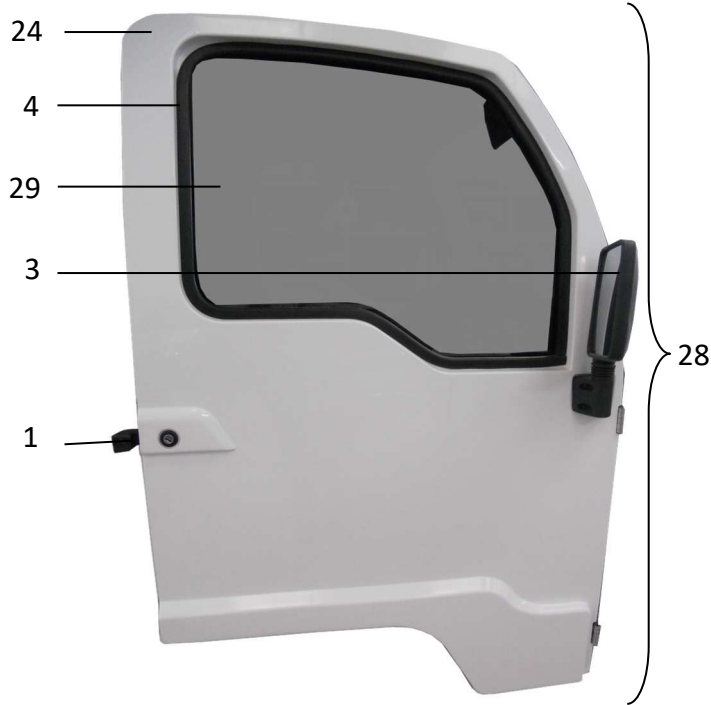

- 15
- 14
- 3
- 8
- 12
- 7
- 13
- 25
- 26

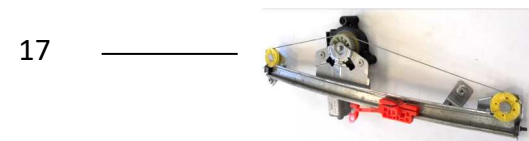
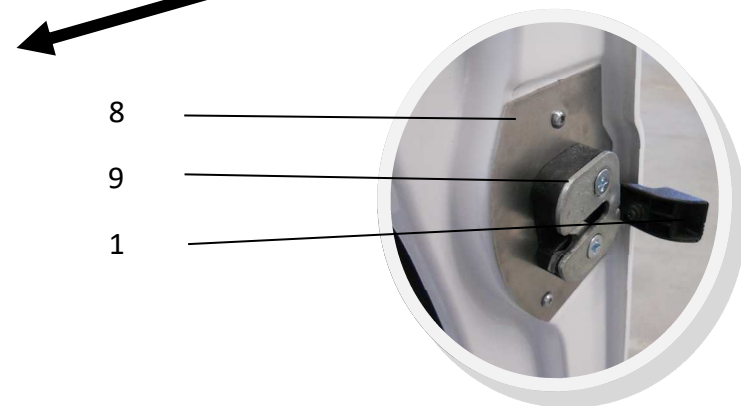

Repère	Q.TE	Référence	Désignation
1	1	001001A4	BOUTON SERRURE D
3	1	001001B2	RETROVISEUR EXT D
4	1	00600116	JOINT COULISSE LECHEUR PORTE
5	1	00502970	GARNITURE PORTE D
6	1	00502972	BANDEAU VIDE POCHE D
7	1	00502973	BANDEAU PORTE-BOUTEILLE D&G
8	1	00100171	PLATINE FIXATION MECANISME
9	1	00100167	GACHE PORTE D
11	1	00500117	POIGNEE PORTE INT D
12	1	00100169	SANGLE ARRET PORTE
13	1	01450609	HAUT-PARLEUR (PAIRE)
14	1	00500127	BARILLET PORTE D&G
15	1	00100160	SERRURE PORTE D
17	1	01450102	LEVE-VITRE ELECTRIQUE D
18	1	00600102	JOINT GLISSIERE VITRE
19	1	00100301	COULISSE AR D
20	1	00500128	CLIP BARILLET PORTE
21	1	00100307	SUPPORT COULISSE AR D
22	1	00100134	CHARNIERE PORTE D&G
23	1	001001A6	TRINGLE PORTE
24	1	SEPORTENUEDOCKD	PORTE NUE D
25	1	00500129	LIAISON BARILLET PORTE
26	1	00100170	PLATINE FIXATION SANGLE
27	1	00502300	SOUFFLET PASSE-FAISCEAU
28	1	SEPORTEDDOCK2	PORTE COMPLETE D
29	1	01803704	GLACE PORTE D







Repère	Q.TE	Référence	Désignation
2	2	00250511	AMORTISSEUR AV
5	2	00250512	AMORTISSEUR AR
10	1	00259901	AXE VIS BRAS AR
11	1	00103910	OBTURATEUR CHASSIS 25X25
12	1	00153900	OBTURATEUR CHASSIS 30X30
13	2	00252111	ROTULE INF DE SUSPENSION
14	1	00302113	TRIANGLE G BAGUE
15	1	00302114	TRIANGLE D BAGUE
16	1	00153012	CHASSIS
17	1	00252119	BRAS SUSPENSION BAGUE AR D
18	1	00252120	BRAS SUSPENSION BAGUE AR G

	<b>100</b>	<b>CHASSIS + SUSPENSION</b>	<b>DOCKER</b>
-------------------------------------------------------------------------------------	------------	-----------------------------	---------------

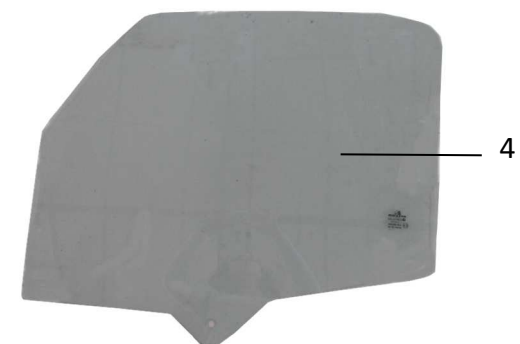
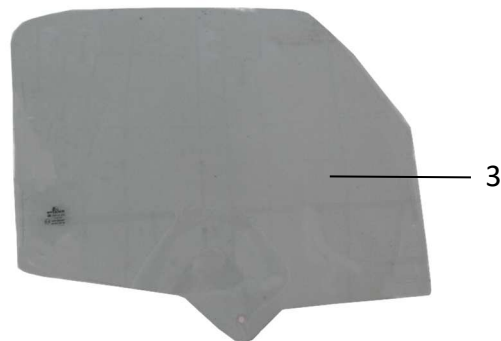

Repère	Q.TE	Référence	Désignation
1	1	00804903	PARE-BRISE
2	1	00800726	LUNETTE AR
3	1	01803704	GLACE PORTE D
4	1	01804705	GLACE PORTE G
5	1	00804003	PINCEAU APPLICATEUR PRIMAIRE

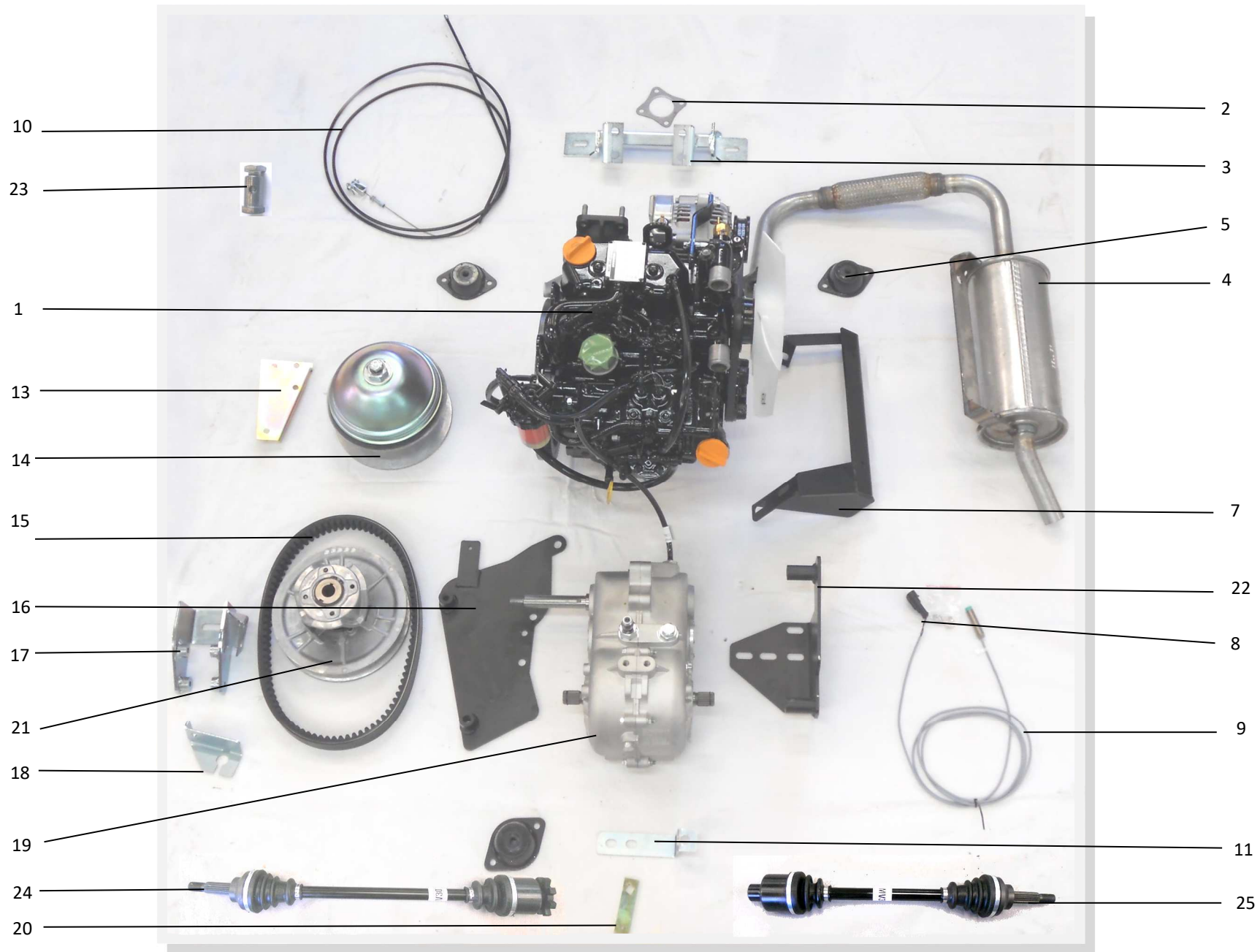

Repère	Q.TE	Référence	Désignation
1	1	000004A3	MOTEUR YAN
2	1	00000406	JOINT COLLECTEUR ECHAPPEMENT
3	1	00004203	SUPPORT MOTEUR AV
4	1	00951733	LIGNE ECHAPPEMENT
5	3	00980402	SILENTBLOC
7	1	00001711	SUPPORT RADIATEUR INF
8	1	00452344	CONNECTEUR SUPERSEAL 3 VOIES
9	1	00450818	CAPTEUR DE VITESSE
10	1	00652010	CABLE ACCELERATEUR
11	1	01154201	SUPPORT CAPTEUR DE VITESSE
13	1	000004B0	SUPPORT FILTRE A AIR
14	1	00201050	POULIE MOTRICE
15	1	00204455	COURROIE
16	1	000004A7	PLAQUE LIAISON BOITE MOTEUR D
17	1	00204207	SUPPORT BOITE AR
18	1	00201511	PATTE SUPPORT CABLE SELECTEUR
19	1	00201472	BOITE INVERSEUR 1/10
20	1	00201405	PATTE SELECTEUR
21	1	00202509	POULIE RECEPTRICE
22	1	000004A8	PLAQUE LIAISON BOITE MOTEUR G
23	1	00652013	SERRE-CABLE ACCELERATEUR
24	1	00202822	TRANSMISSION AR D & ROUE
25	1	00202816	TRANSMISSION AR G

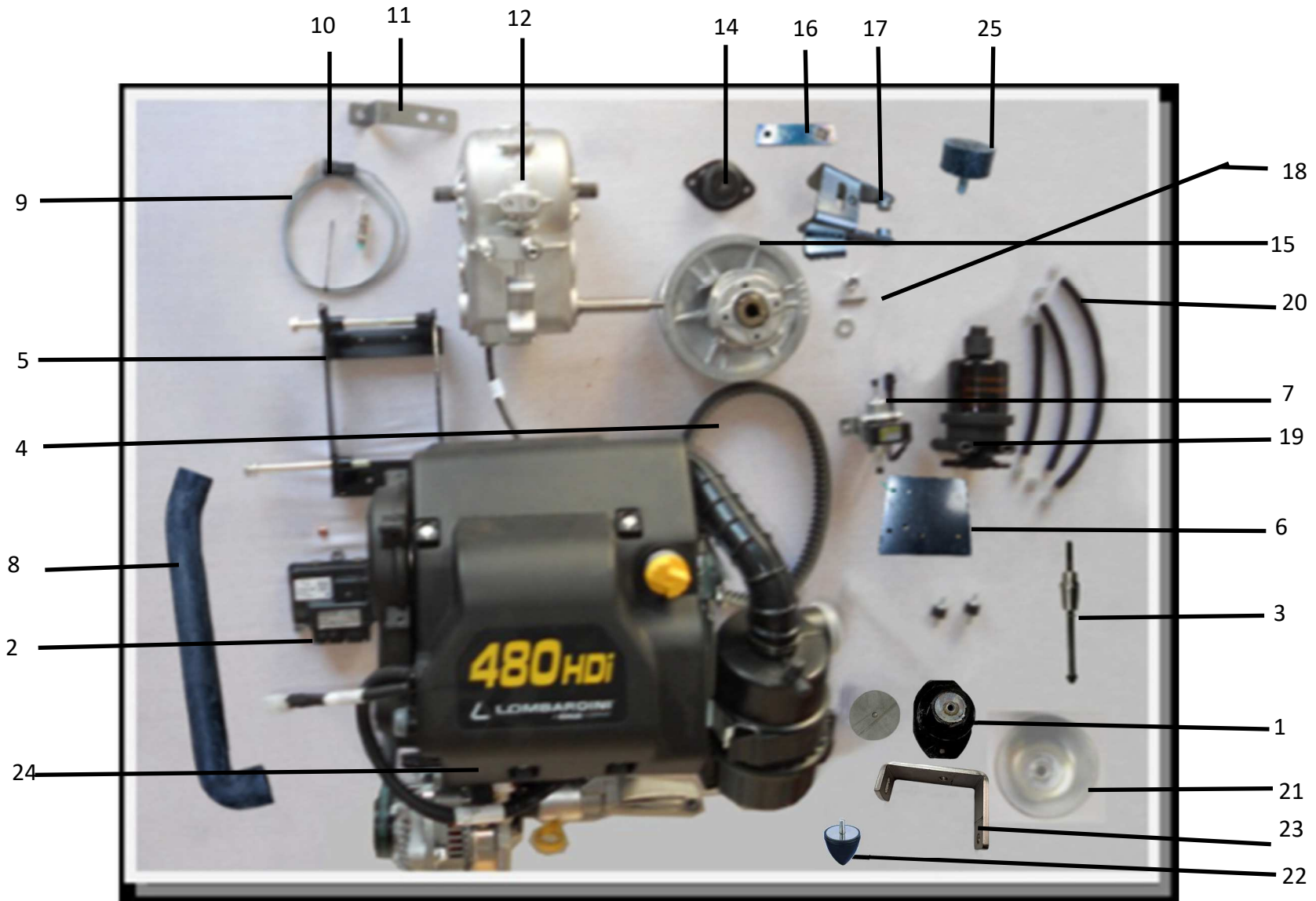

Repère	Q.TE	Référence	Désignation
1	2	00980400	SILENTBLOC MOT/BOITE DV-OP-JA-B8-DOC AV- 45SH
2	1	00050802	CALCULATEUR
3	1	00050803	CONE VARIATEUR + VISSERIE
4	1	00204466	COURROIE
5	1	02004204	SUPPORT MOTEUR BOITE MILIEU
6	1	00153014-05	PLAQUE SUPPORT FILTRE
7	1	00050804	POMPE A GASOIL
8	1	00004624	DURITE ASPIRATION FILTRE AIR
9	1	00450818	CAPTEUR DE VITESSE
10	1	00452344	CONNECTEUR SUPERSEAL 3 VOIES
11	1	01154201	SUPPORT CAPTEUR DE VITESSE
12	1	00201472	BOITE INVERSEUR
14	1	00980402	SILENTBLOC MOT/BOITE AR 65SH UT-JADE-KIM -DOC
15	1	00202510	POULIE RECEPTRICE
16	1	00201405	PATTE SELECTEUR DV-DOC2
17	1	00204207	SUPPORT BOITE AR UT-DOC
18	1	00201001	CLAVETTE VARIATEUR BOITE UT-DV
19	1	00052220	SUPPORT FILTRE GO + CARTOUCHE
20	3	00364605	DURITE GASOIL 1M50
21	1	00201049	POULIE MOTRICE V2 OP2-JA B8
22	2	02980401	SILENTBLOC CONIQUE PATTE MOTEU
23	1	02054200	PATTE BUTEE CONIQUE B8 DOC
24	1	02050400	MOTEUR LOMB LDW 480 HDI
25	1	000504C2	SILENTBLOC MOTEUR DOC2





Repère	Q.TE	Référence	Désignation
1	1	00951734	COLLECTEUR DOCKER DCI
2	1	00951735	INTERMEDIAIRE ECHA DOCKER DCI
3	1	00951733	ECHAPPEMENT DOCKER DCI
4	3		COLLIER
5	1		

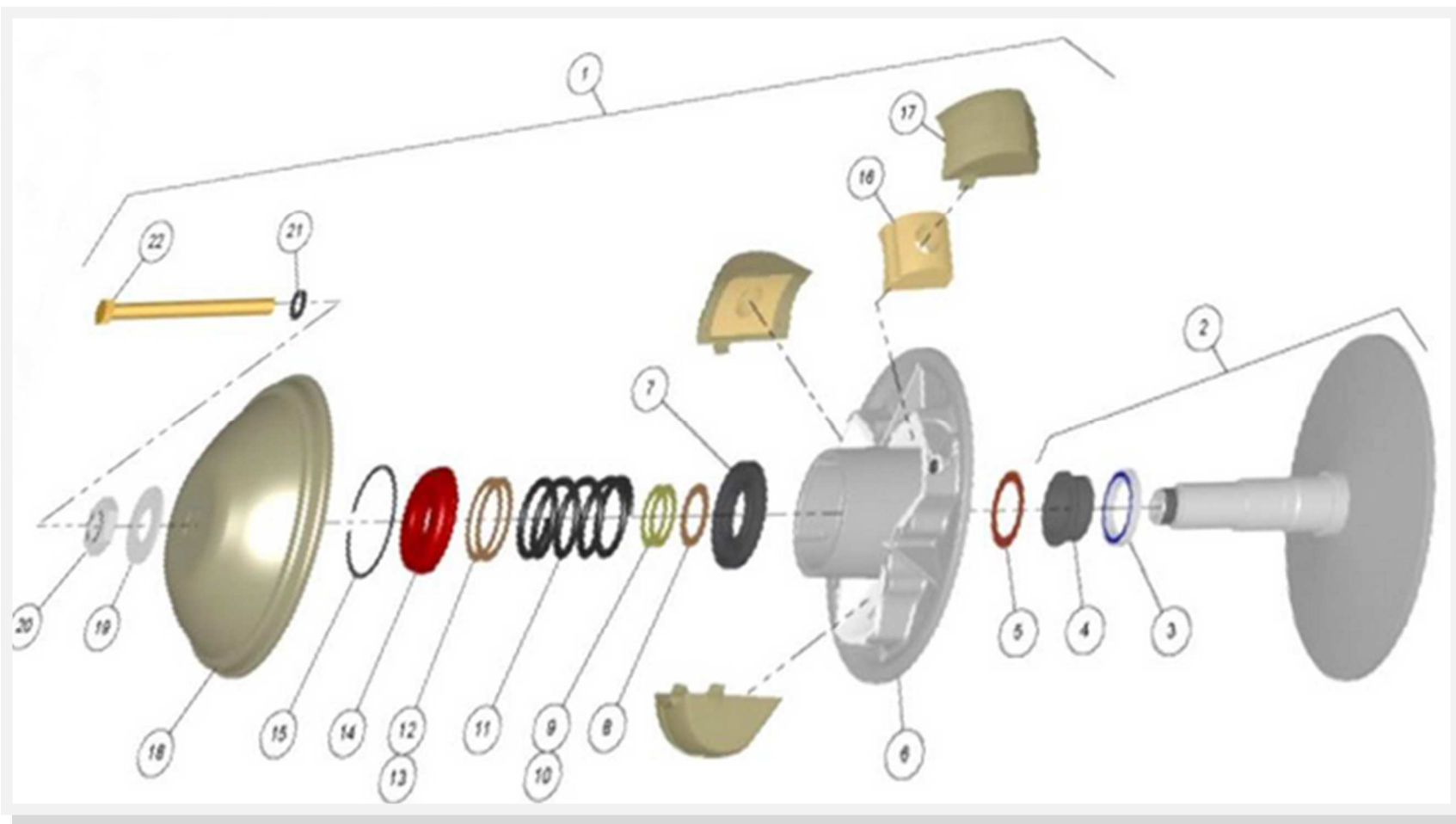

Repère	Q.TE	Référence	Désignation
1	1	00201053	POULIE MOTRICE
2			FLASQUE FIXE
3	1	00201038	ROULEMENT DEBRAYAGE MOTRICE
4			BAGUE DE SERRAGE
5			RONDELLE D ESPACEMENT
6	1	00201031	FLASQUE COULISSANT
7	1	00201041	COUSSINET INF
8			RONDELLE D ESPACEMENT
9			RONDELLE D ESPACEMENT
10			RONDELLE D ESPACEMENT
11	1	00202551	RESSORT
12	1	00202533	CALE COURROIE ASA1
13	1	00201003	CALE COURROIE ASA1S
14	1	00201040	COUSSINET SUPERIEUR
15	1	00201030	SEGMENT D ARRET C15
16	1	00202552	MASSELOTTE
17			BLOC CENTRIFUGE
18			CAPUCHON
19			RONDELLE
20			ECROU DE BLOCAGE
21			RONDELLE DE FIXATION
22			BOULON DE FIXATION

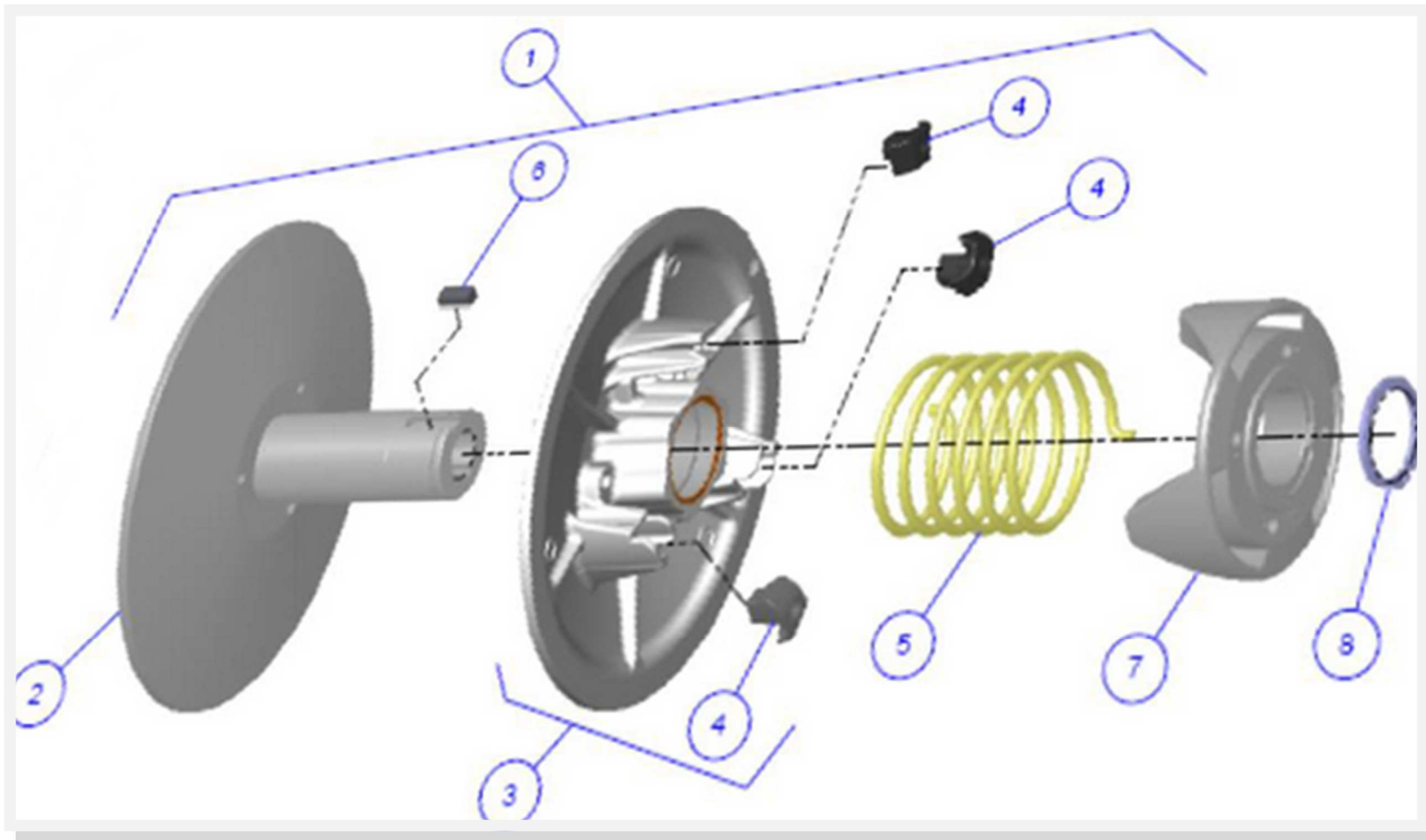

<b>Repère</b>	<b>Q.TE</b>	<b>Référence</b>	<b>Désignation</b>
1	1	00202510	POULIE RECEPTRICE
2			FLASQUE FIXE
3			FLASQUE COULISSANT
4	3	00202544	PATIN DE CAME
5	1	00202516	RESSORT POULIE RECEP DOCKER
6			CLAVETTE
7			CAME
8	1	00202533	SEGMENT D ARRET EXT COURROIE

	<b>140</b>	<b>POULIE RECEPTRICE</b>	<b>DOCKER</b>
-------------------------------------------------------------------------------------	------------	--------------------------	---------------

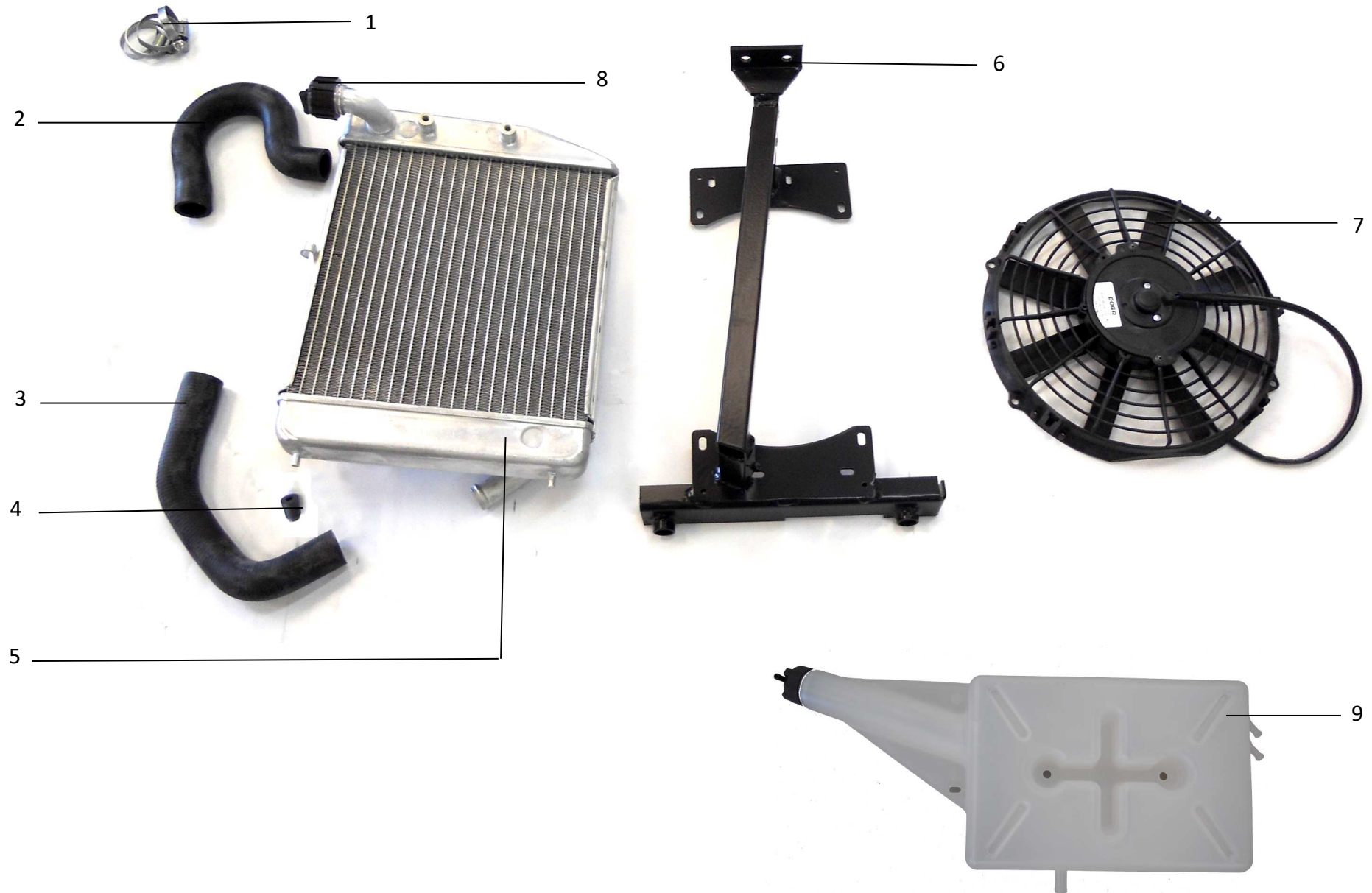

<b>Repère</b>	<b>Q.TE</b>	<b>Référence</b>	<b>Désignation</b>
1	4	000004B2	COLLIER 25X40
2	1	00004605	DURITE SUP EAU
3	1	00004621	DURITE INF EAU RADIATEUR ALU
4	2	00981702	SILENTBLOC RADIATEUR ALU
5	1	00001702	RADIATEUR ALU
6	1	00001719	SUPPORT RADIATEUR ALU
7	1	00450876	VENTILATEUR REFROIDISSEMENT
8	1	00001723	BOUCHON RADIATEUR
9	1	01051705	VASE EXPANSION

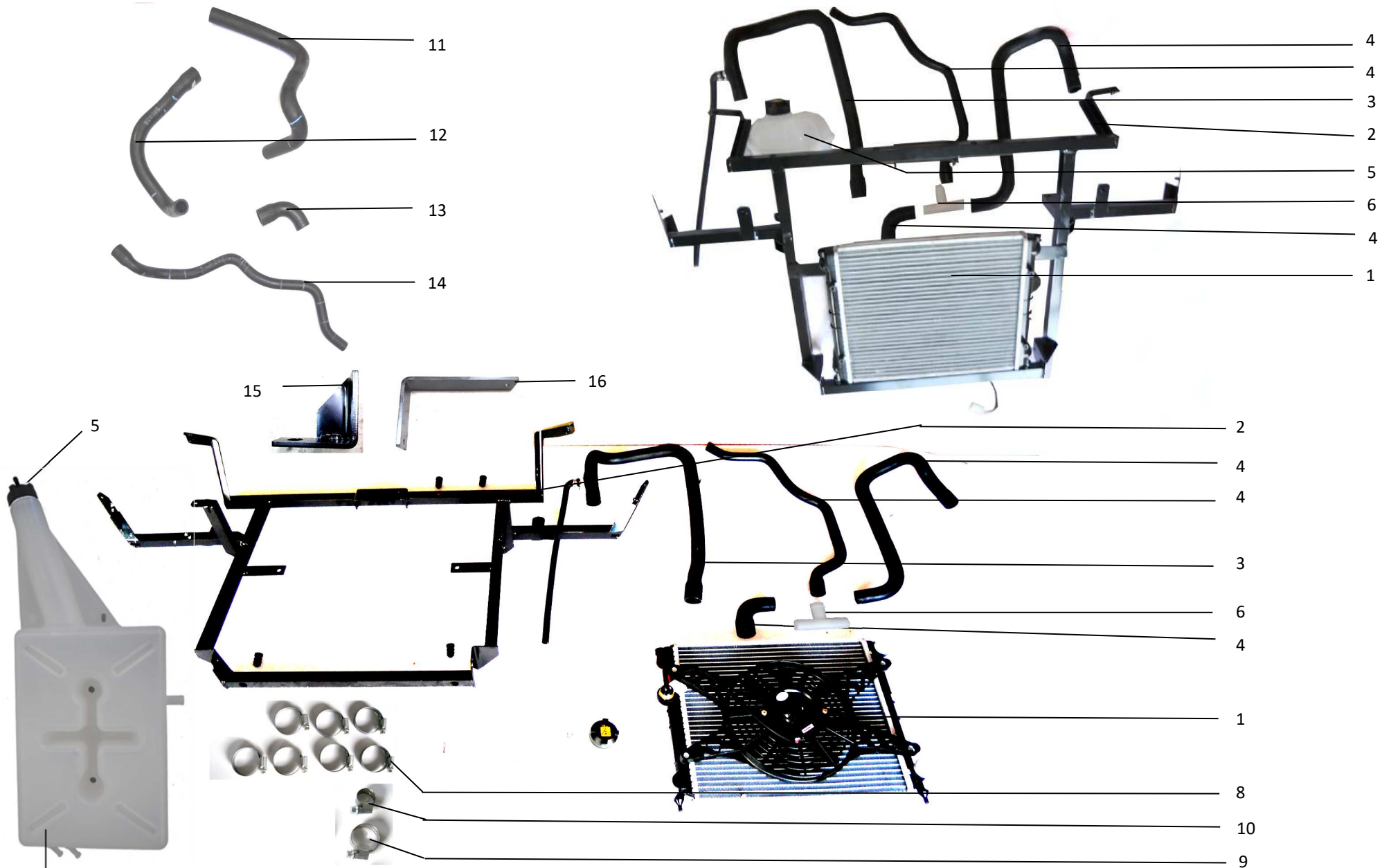



Repère		Référence	Désignation
1	1	02001700	RADIATEUR FRONTAL
2	1	02153006	MASQUE AV SUPPORT PHARE
3	1	02004600	KIT 2 DURITES SUPERIEURES RADIATEUR
4	1	02004601	KIT 3 DURITES INFERIEURES RADIATEUR
5	1	01051705	VASE D'EXPANSION
6	1	02004603	RACCORD EN T D25
8	7	000004B2	COLLIER 25/40
9	1	000004B1	COLLIER 16/27
10	1	000004C5	COLLIER 8/16
12	1	02054603	DURITE SUPERIEURE RAD
11	1	02054600	DURITE INFERIEURE RADIATEUR LOMB
13	1	02054602	DURITE COUDEE INF RAD
14	1	02054601	DURITE RETOUR VASE MOTEUR LOMB
15	2	00153014-01	Patte support radiateur INF
16	2	00153014-02	Patte support radiateur SUP

	<b>155</b>	<b>SYSTÈME DE REFROIDISSEMENT LOMB</b>	<b>DOCKER</b>
-------------------------------------------------------------------------------------	------------	----------------------------------------	---------------

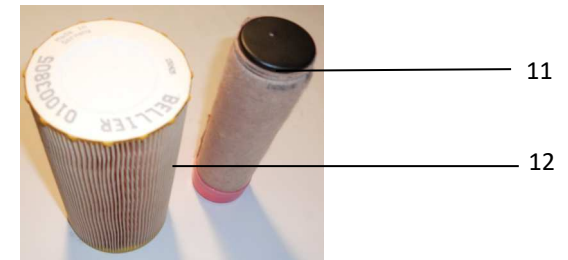
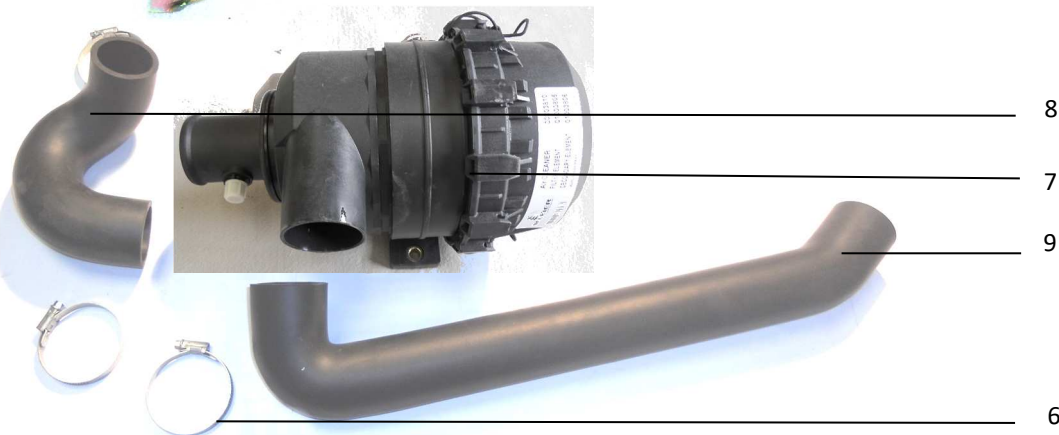
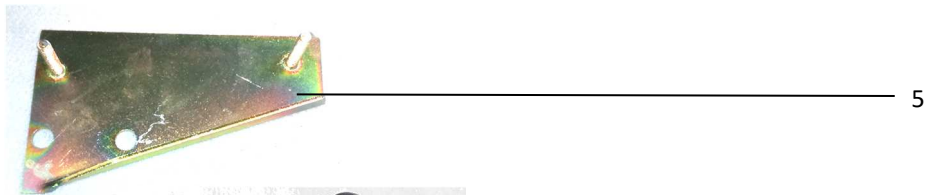
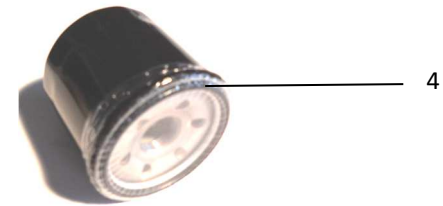
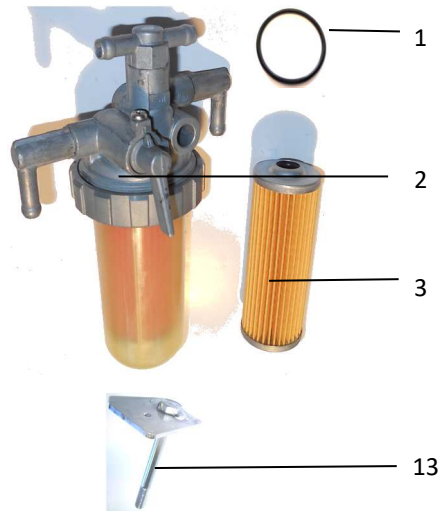

Repère	Q.TE	Référence	Désignation
1	1	00000411	JOINT TORIQUE
2	1	00003805	SUPPORT ET FILTRE GO COMPLET
3	1	00003802	FILTRE GO YAN
4	1	00003803	FILTRE A HUILE YAN
5	1	000004B0	SUPPORT FILTRE AIR
6	3	000004A5	COLLIER 50/60
7	1	00003810	BOITIER FILTRE A AIR
8	1	00004601	DURITE FILTRE A AIR COUDEE
9	1	00004615	DURITE ASPIRATION FILTRE A AIR
11	1	01003806	CARTOUCHE SECONDAIRE FILTRE
12	1	01003805	CARTOUCHE PRINCIPALE
13	1	02004205	SUPPORT FILTRE GO



3

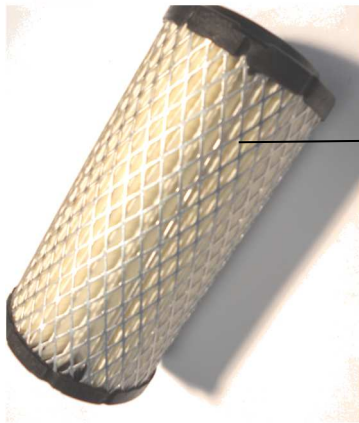

4



1

2

<b>Repère</b>	<b>Q.TE</b>	<b>Référence</b>	<b>Désignation</b>
1	1	00053807	FILTRE GO LOMB DCI
2	1	00052220	SUPPORT FILTRE GO + CARTOUCHE
3	1	00053812	FILTRE HUILE LOMB DCI
4	1	00053813	CARTOUCHE DE FILTRE AIR LOMBARDINI

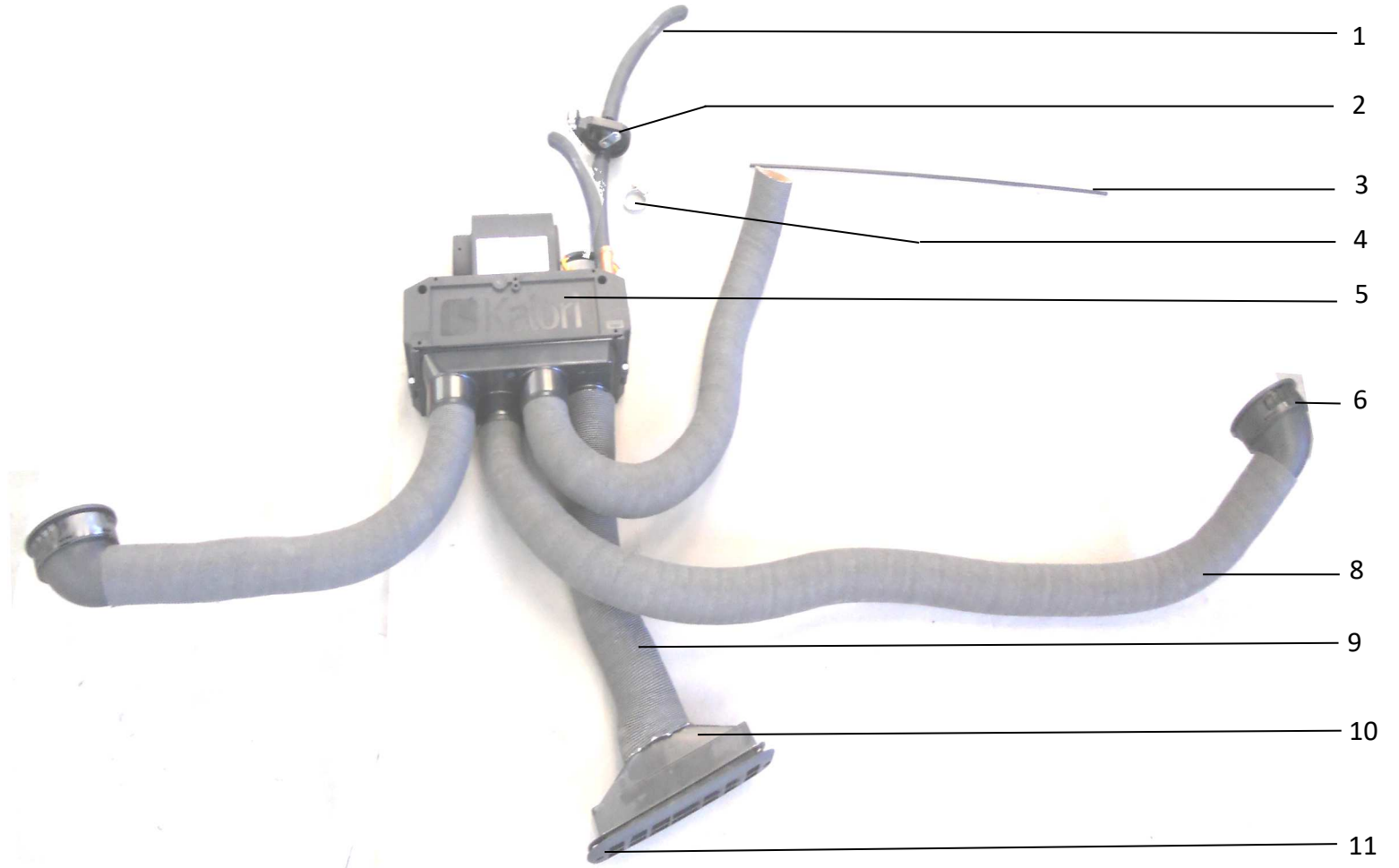

Repère	Q.TE	Référence	Désignation
1	2	00004619	DURITE D16MM EAU CHAUFFAGE
2	1	00501617	ROBINET DE CHAUFFAGE
3	1	00651607	CABLE COMMANDE CHAUFFAGE
4	10	000004B1	COLLIER 16X27
5	1	00451617	CHAUFFAGE COMPACT
6	2	00501606	BOUCHE CHAUFFAGE KB NOIRE
8	3	00504603	GAINÉ CHAUFFAGE PAP45—650mm—460mm—1080mm
9	1	01501616	GAINÉ CHAUFFAGE PAP55—340mm
10	2	00451616	QUEUE CARPE CHAUFFAGE
11	2	00501618	GRILLE DESEMBUAGE
12	1	00001720	RACCORD EN T
13	1	00501619	SUPPORT CHAUFFAGE



1

2

4

11

3

8

5

6

10

7



12

**DIESEL**

9



13



Repère	Q.TE	Référence	Désignation
1	1	A1354600	GOULOTTE REMPLISSAGE GO
2	1	----	DURITE AU M L: 740mm
3	1	----	DURITE AU M L : 650mm
4	1	00354605	DURITE GO AU M L: 500mm / 240mm / 180mm
5	1	02355000	RESERVOIR GO
6	2	00354201	PATTE SUPPORT RESERVOIR GO
7	1	A1350100	BOUCHON ANTIVOL RESERVOIR
8	2	00354606	TUYAU GO MANURIL 6 X 8
9	1	00102915	AUTOCOLLANT « DIESEL
10	1	02350800	JAUGE RESERVOIR
11	1	00053803	PREFILTRE
12	1	----	ANCIEN RESERVOIR REMPLACE PAR 02355000)
13	1	----	ANCIENNE JAUGE REMPLACE PAR 02350800)

	<b>180</b>	<b>RESERVOIR GASOIL</b>	<b>DOCKER</b>
-------------------------------------------------------------------------------------	------------	-------------------------	---------------

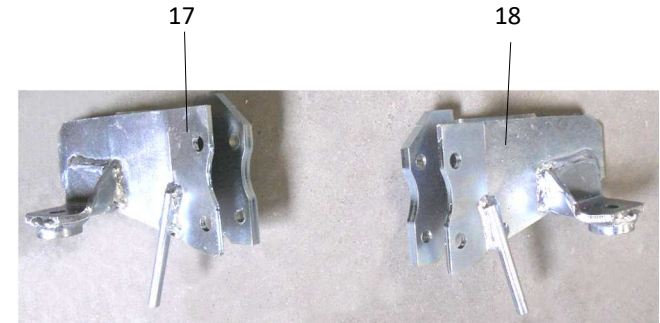
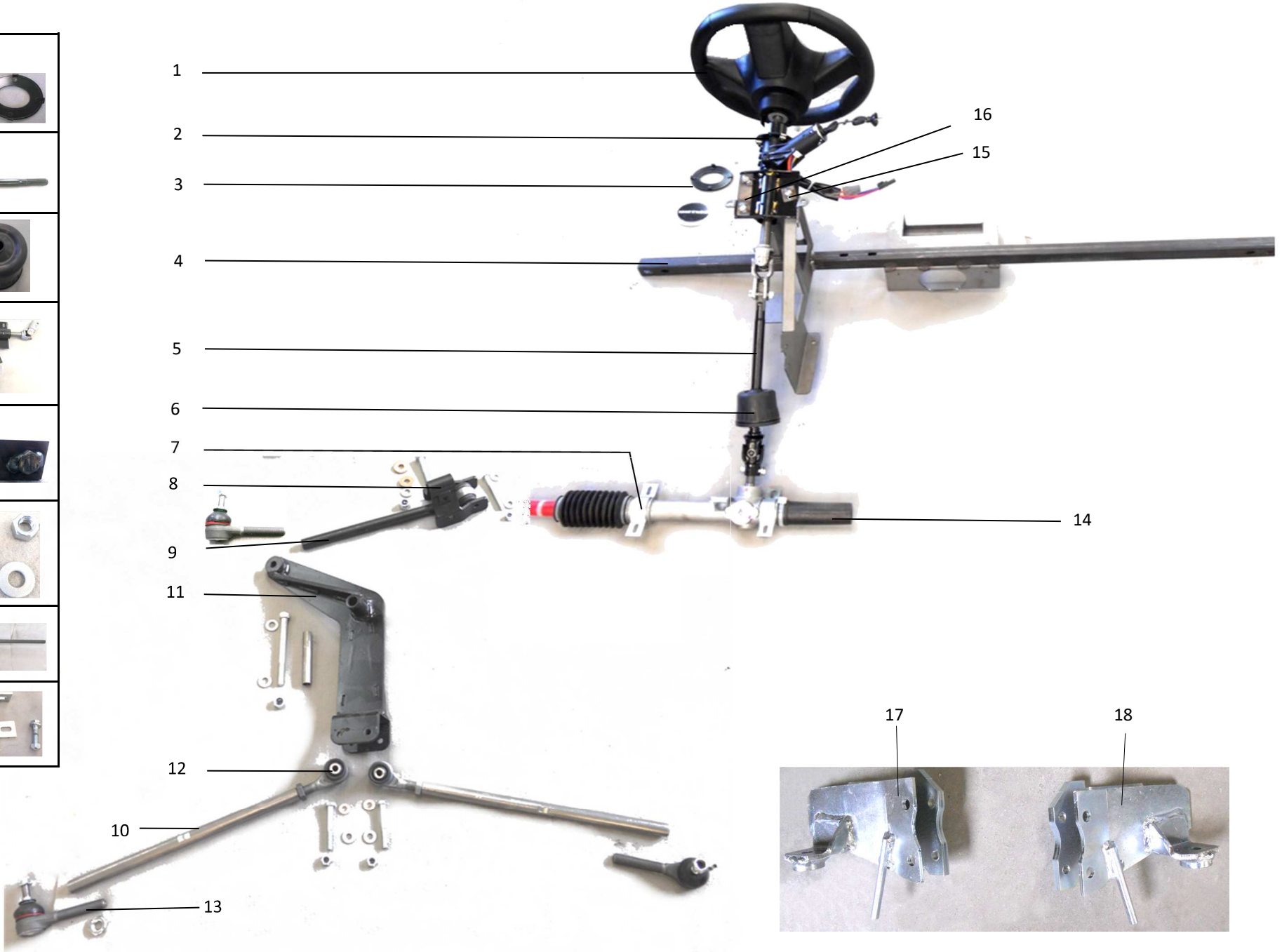
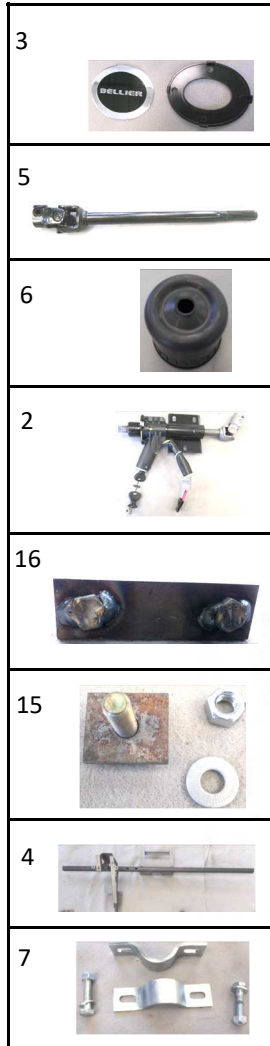

Repère	Q.TE	Référence	Désignation
1	1	02300903	VOLANT B8 STANDARD
2	1	00300943	COLONNE DIRECTION + NEIMAN
3	1	00500900	LOGO VOLANT BELLIER
4	1	00102923	STRUCTURE SOUS PDB
5	1	00300951	RALLONGE COLONNE DIRECTION
6	1	00300972	SOUFFLER RALLONGE COLONNE
7	2	00300962	COQUILLE CREMAILLERE
8	1	00300934	CHAPE SUPPORT ROTULE
9	1	00300970	BIELLETTTE COURTE NUE
10	2	00300903	BIELLETTTE LONGUE NUE
11	1	00200961	LEVIER DE DIRECTION AVEC BAGUES
12	2	00300940	ROTULE CREMAILLERE A OEIL
13	3	00300912	ROTULE CREMAILLERE
14	1	00300932	CREMAILLERE DIRECTION
15	1	00300959	PLATINE SERRAGE SIMPLE
16	1	00300958	PLATINE SERRAGE DOUBLE
17	1	00300947	TIRANT DE DIRECTION G
18	1	00300948	TIRANT DE DIRECTION D

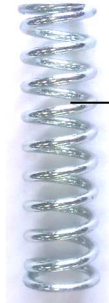

1

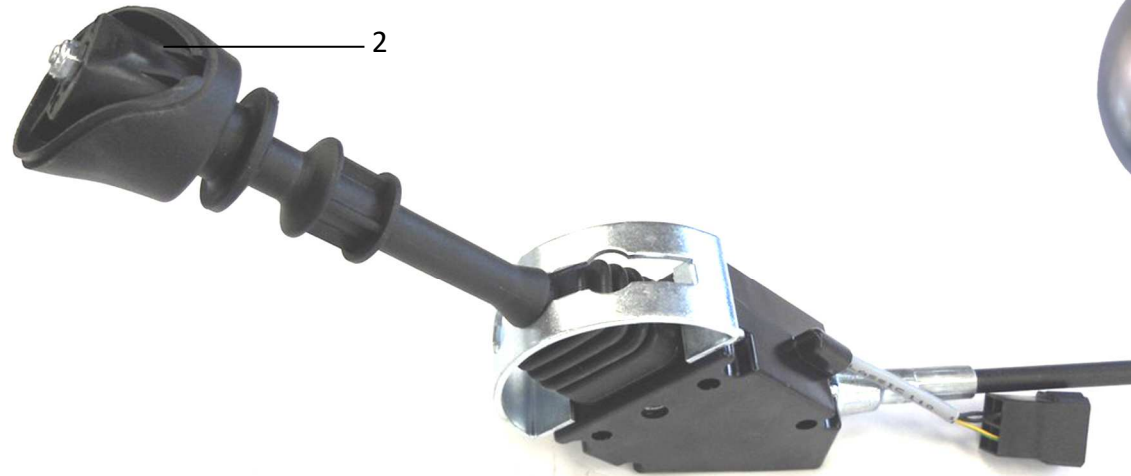

2

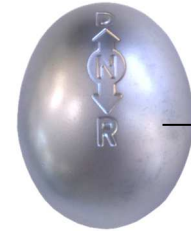

3

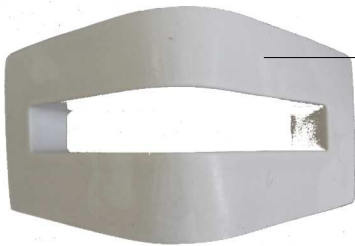

4





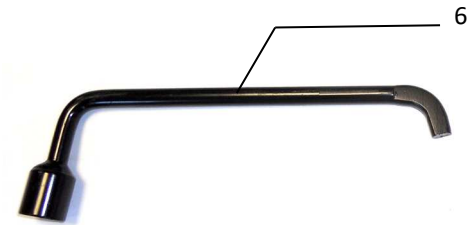
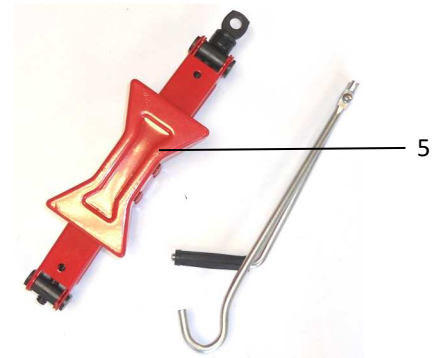
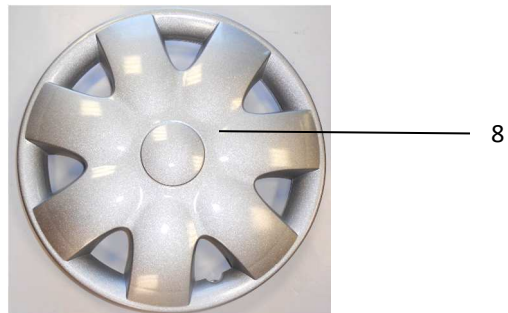
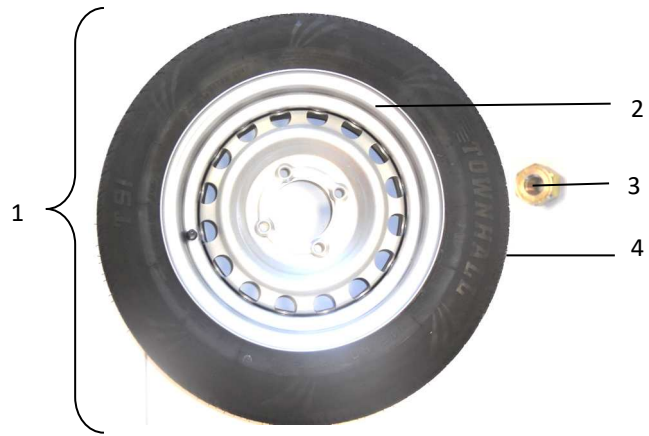





<b>Repère</b>	<b>Q.TE</b>	<b>Référence</b>	<b>Désignation</b>
1	1	00201512	RESSORT CABLE INVERSEUR
2	1	00201510	BOITIER INVERSEUR MARCHE
3	1	02201501	POMMEAU INVERSEUR
4	1	00102926	SUPPORT INVERSEUR

	<b>220</b>	<b>BOITIER INVERSEUR</b>	<b>DOCKER</b>
-------------------------------------------------------------------------------------	------------	--------------------------	---------------



Repère	Q.TE	Référence	Désignation
1	1	01303112	ROUE COMPLETE 145 80 R13
2	1	01303122	JANTE TOLE
3	4	00993101	ECROU ROUE
4	1	01303123	PNEU 145 80 R13
5	1	00303129	CRIC
6	1	00303106	CLE
7	1	00303122	BOMBE ANTI-CREVAISON
8	1	00753108	ENJOLIVEUR 13'

	<b>230</b>	<b>ROUES</b>	<b>DOCKER</b>
-------------------------------------------------------------------------------------	------------	--------------	---------------



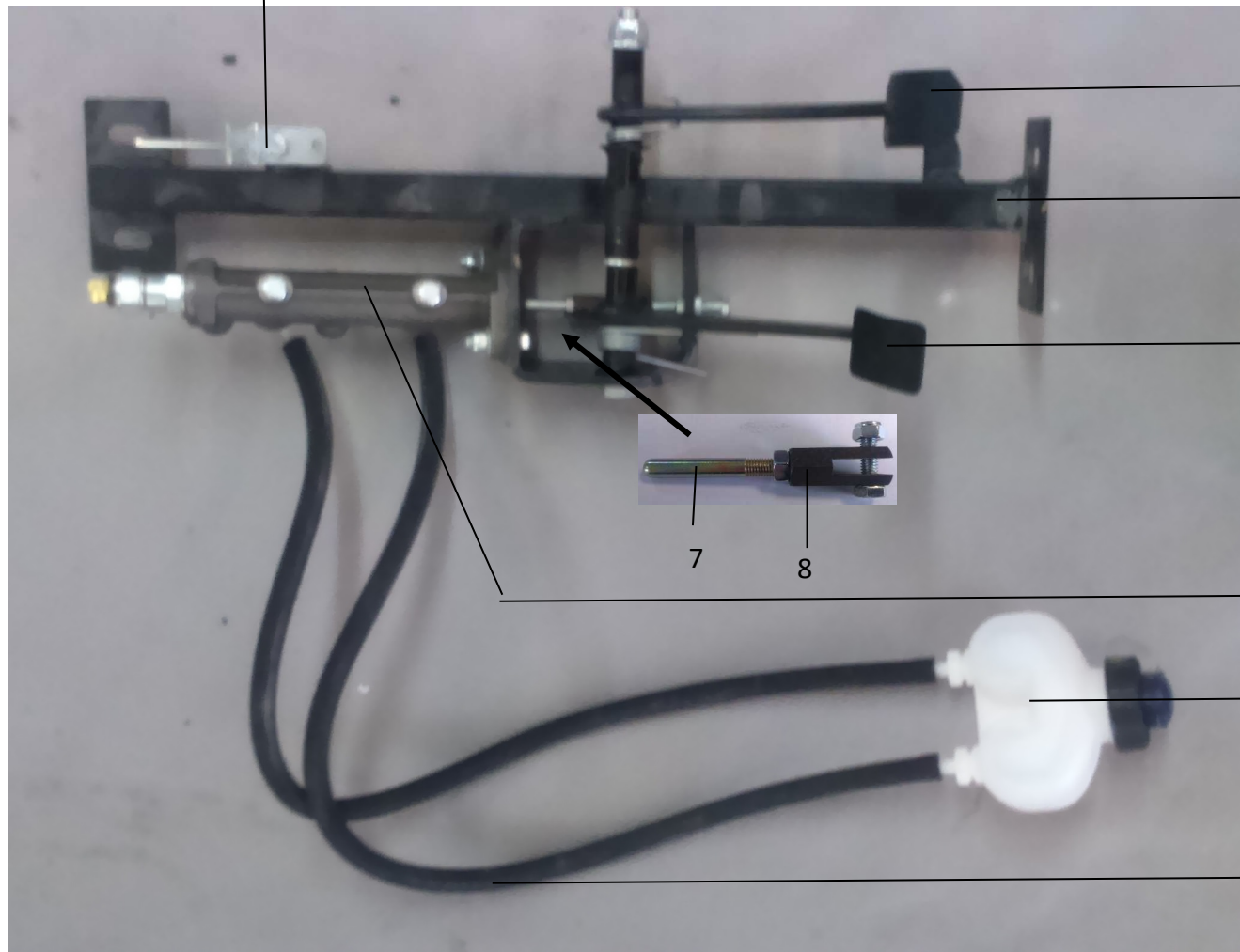







- 1 
- 3 
- 7 
- 8 
- 9 
- 10 
- 11 
- 12 
- 13 
- 14 



- 1
- 2
- 3
- 4
- 5
- 6



Repère	Q.TE	Référence	Désignation
1	1	00502014	PEDALE ACCELERATEUR
2	1	00502010	SUPPORT PEDALIER
3	1	00502012	PEDALE DE FREIN
4	1	00702040	MAITRE CYLINDRE & PIPETTE
5	1	00352003	RESERVOIR LIQUIDE DE FREIN
6	2	00702042	TUBE TRESSE MAITRE CYLINDRE
7	1	00502015	TIGE POUSSEE
8	1	00702066	CHAPE PEDALE FREIN
9	1	00502002	RESSORT PEDALE DE FREIN
10	1	00502013	RESSORT PEDALE ACCELERATEUR
11	1	00702059	COIFFE-PEDALE
12	1	00452003	CONTACTEUR FEU STOP
13	1	00702043	SUPPORT RESERVOIR LIQUIDE
14	1	00703649	JOINT CUIVRE FLEXIBLE FREIN

- 11 
- 17 
- 18   

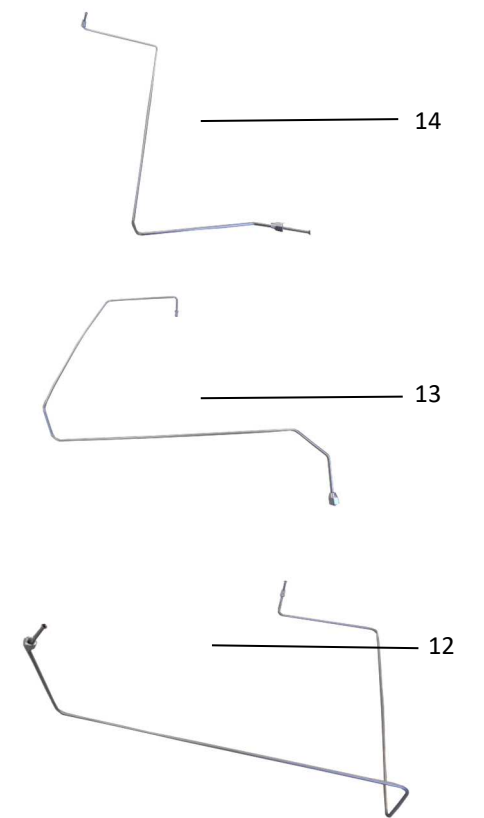
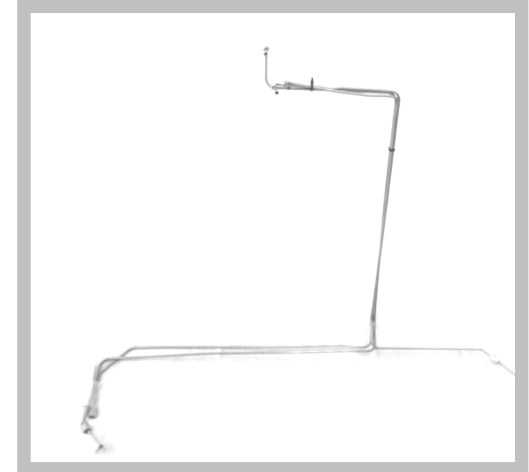
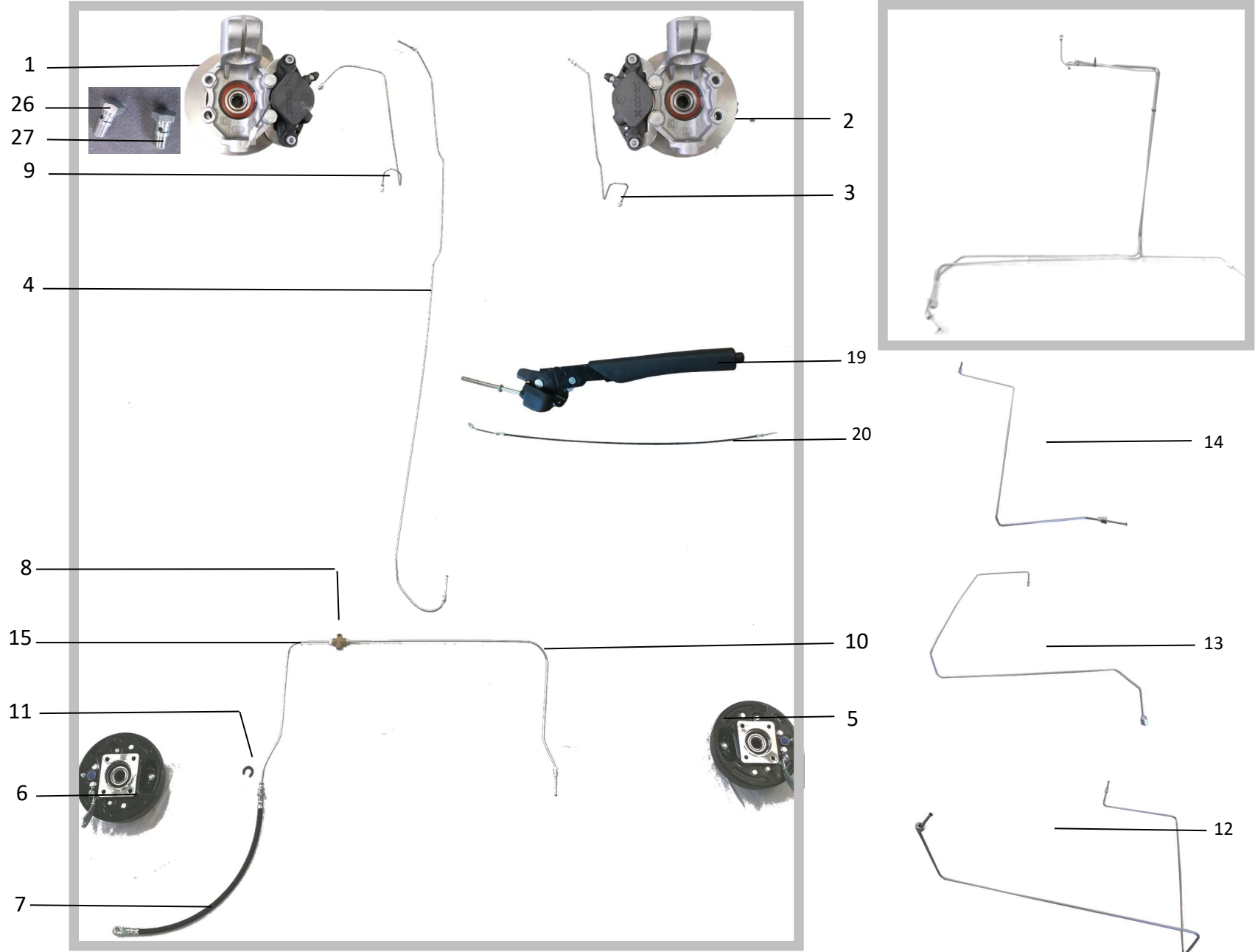
- 21 
- 22 
- 23 
- 8 
- 25 
- 26 
- 27 

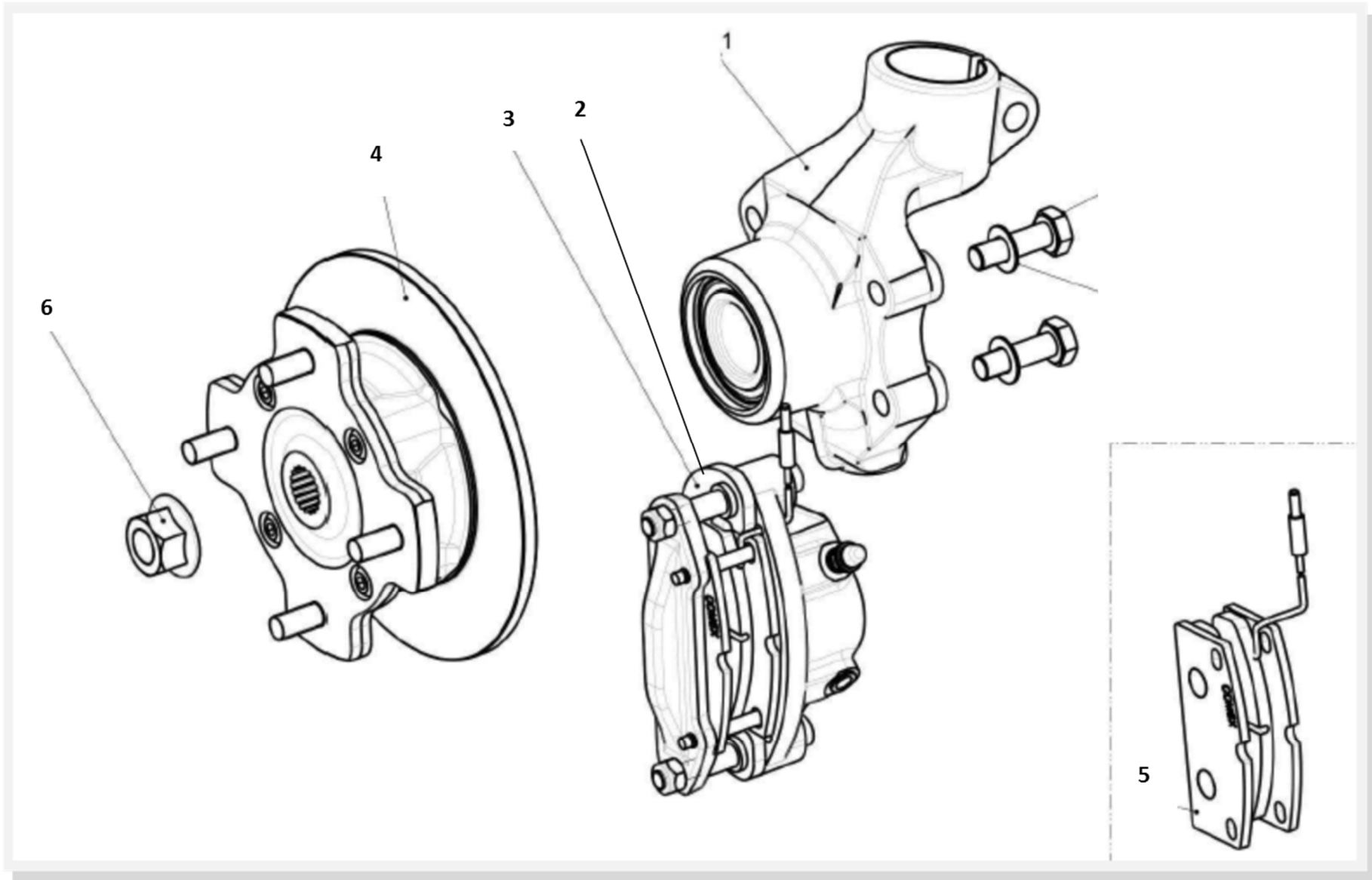

Repère	Q.TE	Référence	Désignation
1	1	00703606	FREIN DISQUE AV G COMPLET
2	1	00703607	FREIN DISQUE AV D COMPLET
3	1	00702069	TUBE FREIN RIGIDE AV D
4	1	00702064	TUBE FREIN RIGIDE
5	1	00703653	FREIN TAMBOUR AR D COMPLET
6	1	00703654	FREIN TAMBOUR AR G COMPLET
7	4	00702020	FLEXIBLE FREIN
8	1	00702051	REPARTITEUR T UT-DV-OP
9	1	00702049	TUBE FREIN RIGIDE AV G
10	1	00702052	TUBE FREIN RIGIDE AR D
11	1	00992008	AGRAFE FLEXIBLE FREIN
12	1	00702070	TUBE FREIN RIGIDE HAUT INTER
13	1	00702071	TUBE FREIN RIGIDE HAUT GAUCHE
14	1	00702072	TUBE FREIN RIGIDE HAUT DROIT
15	1	00702053	TUBE FREIN RIGIDE AR G
17	1	00703674	ARBRE MOYEU AV
18	2	00999953	AGRAFE VERTE OU JAUNE
19	1	00702023	LEVIER DE FREIN A MAIN
20	2	00652009	CABLE FREIN A MAIN
21	9	00703649	JOINT CUIVRE FLEXIBLE DE FREIN
22	2	00704200	PATTE FIXATION AGRAFE FLEXIBLE
23	1	00702060	PALONNIER FREIN MAIN
25	4	00992001	RONDELLE PLASTIQUE FLEXIBLE
26	2	00992010	VIS FLEXIBLE FREIN AR 10/1.25
27	2	00992009	VIS FLEXIBLE FREIN AV 10/1.00

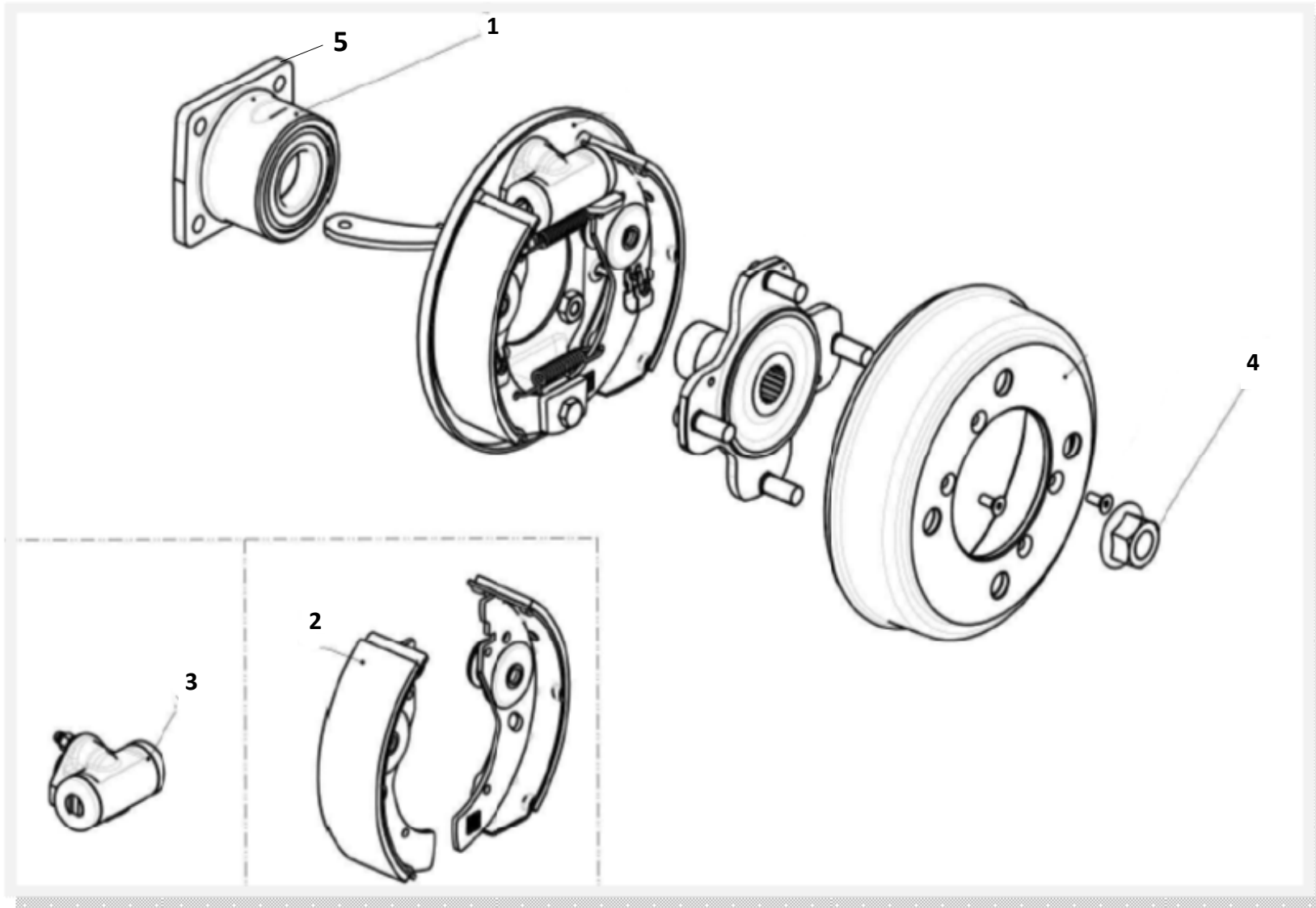

<b>Repère</b>	<b>Q.TE</b>	<b>Référence</b>	<b>Désignation</b>
1	2	00703609	PIVOT ALU FREIN A DISQUE D OU G
2	1	00703676	ETRIER FREIN AV G
3	1	00703613	ETRIER FREIN AV D
4	2	00703610	DISQUE FREIN
5	1	00703614	PLAQUETTE FREIN (JEU 4)
6	1	00999933	ECROU FREIN MOYEU TRANSMISSION



<b>Repère</b>	<b>Q.TE</b>	<b>Référence</b>	<b>Désignation</b>
1	1	00703655	ROULEMENT MOYEU AR
2	1	00703616	MACHOIRE DE FREINS (JEU DE 4)
3	1	00703615	CYLINDRE DE ROUE AR
4	1	00999933	ECROU FREIN MOYEU TRANSMISSION
5	1	00703656	PORTE ROULEMENT MOYEU

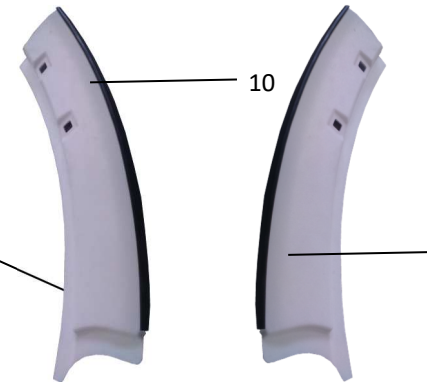
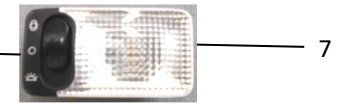
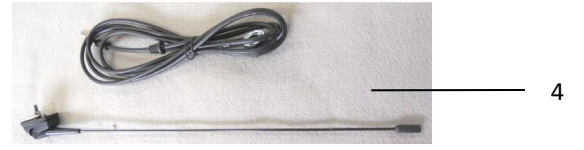
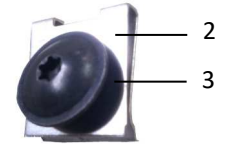
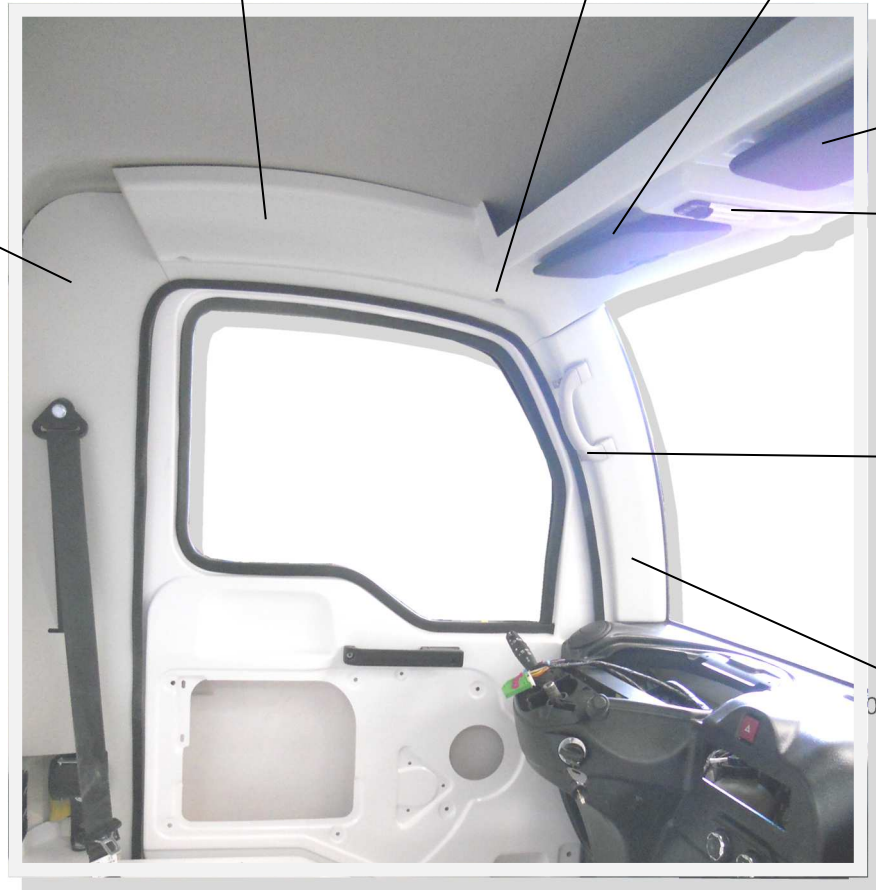
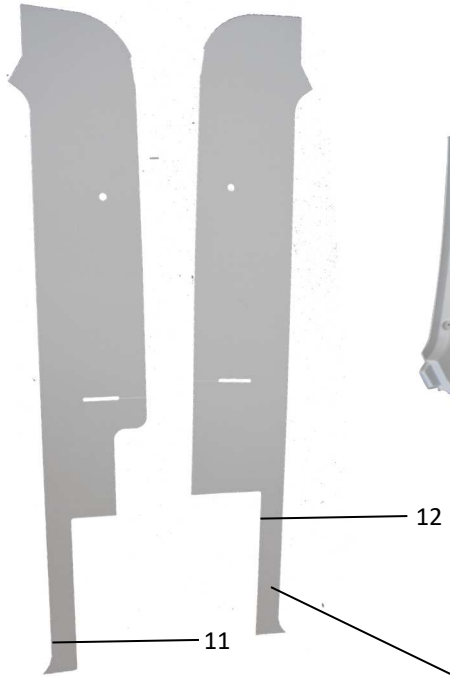



<b>Repère</b>	<b>Q.TE</b>	<b>Référence</b>	<b>Désignation</b>
1	1	00502968	PORTE-DOCUMENTS
2	4	00992011	AGRAFE CLIP
3	4	00999962	VIS 5X16 TB TORX
4	1	00450606	ANTENNE TOIT
5	1	00502949	PARE-SOLEIL G
6	1	00502948	PARE-SOLEIL D
7	1	00450881	PLAFONNIER
8	2	00500138	POIGNEE MAINTIEN
9	1	00502967	JAMBAGE AV D
10	1	00502966	JAMBAGE AV G
11	1	00502974	JAMBAGE AR D
12	1	00502975	JAMBAGE AR G
13	2	00502965	TALONNETTE D & G
14	1	00504205	PATTE SUPPORT PORTE-DOCUMENTS



3



<b>Repère</b>	<b>Q.TE</b>	<b>Référence</b>	<b>Désignation</b>
1	1	01553514	SIEGE D CUIR-TISSU
2	1	01553515	SIEGE G CUIR-TISSU
3	1	00553525	CEINTURE DE SECURITE (PAIRE)

	<b>290</b>	<b>SIEGE</b>	<b>DOCKER</b>
-------------------------------------------------------------------------------------	------------	--------------	---------------



20

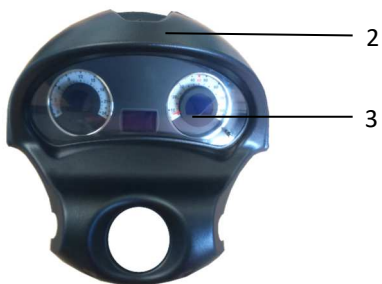

2

3



4



5



17



15



18



11



10

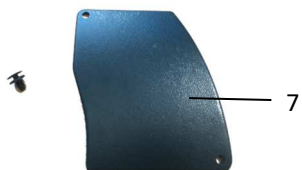

7

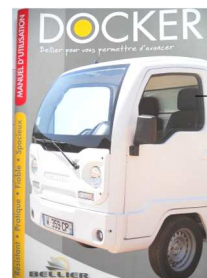

19



9

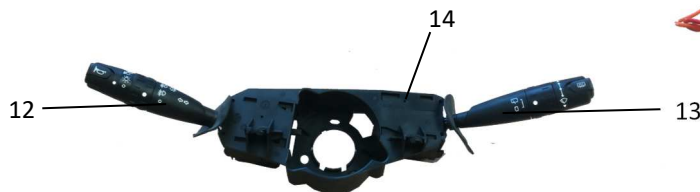

14

12

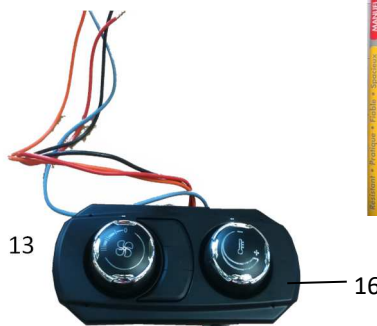

16



1



8



6

Repère	Q.TE	Référence	Désignation
1	2	00451331	INTERRUPTEUR LEVE-VITRE
2	1	00500344	CASQUETTE COMBINE
3	1	00455209	COMBINE
4	1	00450850	CACHE AUTORADIO
5	1	00450615	AUTORADIO CD MP3 USB
6	2	00504209	PATTE FIXATION PDB
7	1	00500345	TRAPPE FUSIBLE
8	1	00451330	INTERRUPTEUR FEU DE DETRESSE
9	1	00502955	FILET LATERAL COFFRE
10	1	00450827	PRISE 12V LUXE
11	1	00500346	JEUX PAD PDB
12	1	00453257	COMMUTATEUR ECLAIRAGE
13	1	00453258	COMMUTATEUR EG
14	1	00453259	SUPPORT COMMUTATEUR
15	1	02300903	VOLANT STANDARD
16	1	00501613	PLATINE CDE CHAUFFAGE
17	1	00500342	PLANCHE BORD
18	1	00500900	LOGO VOLANT BELLIER
19	1	01965324	NOTICE UTILISATION DOCKER V2
20		--	ANCIEN COMBINE REMPLACE PAR LA REFERENCE 00455209



- 3 
- 4 
- 1 
- 7-8 
- 10 
- 9 
- 6 
- 2 
- 5 
- 12 
- 11 



- 14
- 15
- 6
- 1

Repère	Q.TE	Référence	Désignation
14	1	00104113	CELLULE POLYESTER LONGUE & PORTES
1	4	00104103	CHARNIERE PORTE CELLULE
2	4	00500325	ENTRETOISE PLASTIQUE 6MM
3	1	00104104	BUTEE INF PORTE CELLULE
4	1	00104105	BUTEE SUP PORTE CELLULE
5	4	00104106	CONTRE PLAQUE PORTE CELLULE
6	1	00104102	SERRURE A CLE
7	1	00104107	FICHE RESSORT INF D60 INOX
8	1	00104108	FICHE RESSORT SUP G60 INOX
9	8	00104109	BUTEE CELLULE POLYESTER UT
10	2	00104110	CACHE-FICHE RESSORT G60 INOX
11	3.25	00104111	CORNIERE ALU
12	1.52	00104112	PROFIL U ALU
15	1	PRDOCCCELLPOLY 00999999	CELLULE POLYESTER DOCKER PR VISSERIE

	<b>310</b>	<b>CELLULE POLYESTER LONGUE ET PORTES</b>	<b>DOCKER</b>
-------------------------------------------------------------------------------------	------------	-------------------------------------------	---------------

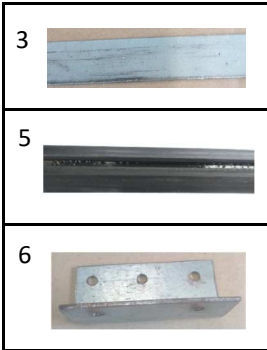



Repère	Q.TE	Référence	Désignation
1	1	00154207	BUTOIR AR DOC AVEC CELLULE
2	1	00104114	CELLULE NON LISSE POLYESTER LONGUE A
3	2	00101509	LATTE SUPPORT PROFIL DOC
6	6	00154208	CORNIERE FIXATION PROFIL DOC
5	2	00602909	PROFIL BUTOIR CELLULE
4	1	00100318	RIDEAU CELLULE
7	1	00104115	CELLULE LISSE
8	1	SECELLULELISSE	ENSEMBLE CELLULE LISSE DOCKER
9	1	SECELLULENONLISSE	ENSEMBLE CELLULE NON LISSE DOC

	<b>320</b>	<b>CELLULE LISSE ET NON LISSE</b>	<b>DOCKER</b>
-------------------------------------------------------------------------------------	------------	-----------------------------------	---------------

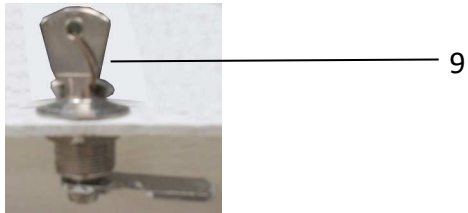

<b>Repère</b>	<b>Q.TE</b>	<b>Référence</b>	<b>Désignation</b>
3	1	00104707	KIT BENNE DOCKER
8	1	00102929	COFFRE DE BENNE
7	1	00102928	COFFRE A OUTILS
1	1	00103313	BACHE LONGUE GRISE
2	1	00103310	ENSEMBLE ARCEAU & TUBE
5	1	00105113	REHAUSSE GRILLAGEE LONGUE D
6	1	00105114	REHAUSSE GRILLAGEE LONGUE G
4	1	00105115	PARE CABINE GRILLAGEE
9	1	00104117	SERRURE A CLE COFFRE A OUTILS
10	18	00993300	ANNEAU BACHE

	<b>330</b>	<b>OPTIONS</b>	<b>DOCKER</b>
--	------------	----------------	---------------

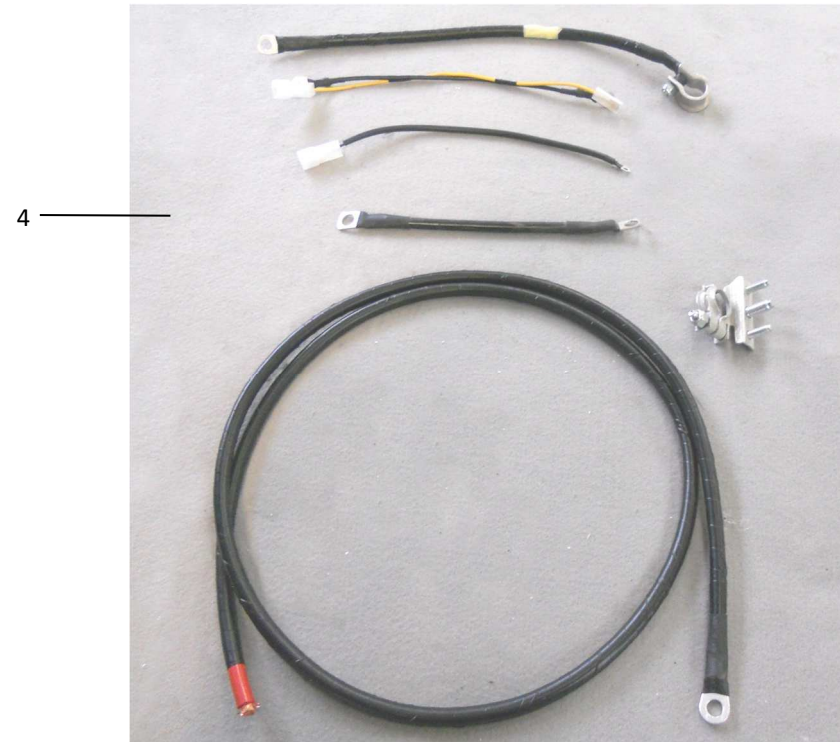
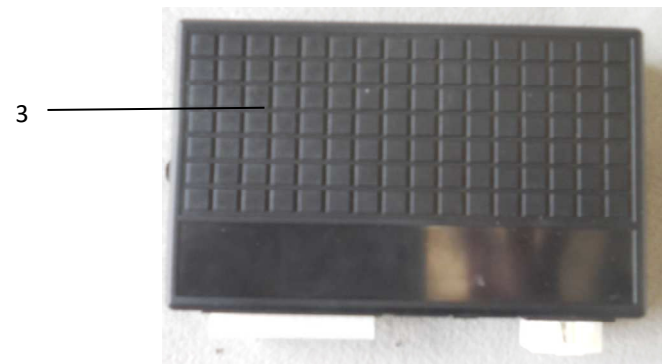

<b>Repère</b>	<b>Q.TE</b>	<b>Référence</b>	<b>Désignation</b>
1	1	00450805	BATTERIE 12V
2	1	00454207	BRIDE BATTERIE
3	1	00450887	MODULE GESTION
4	1	00452329	COMPLEMENT FAISCEAU

**1**

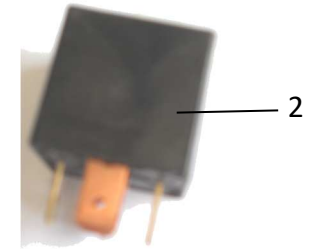
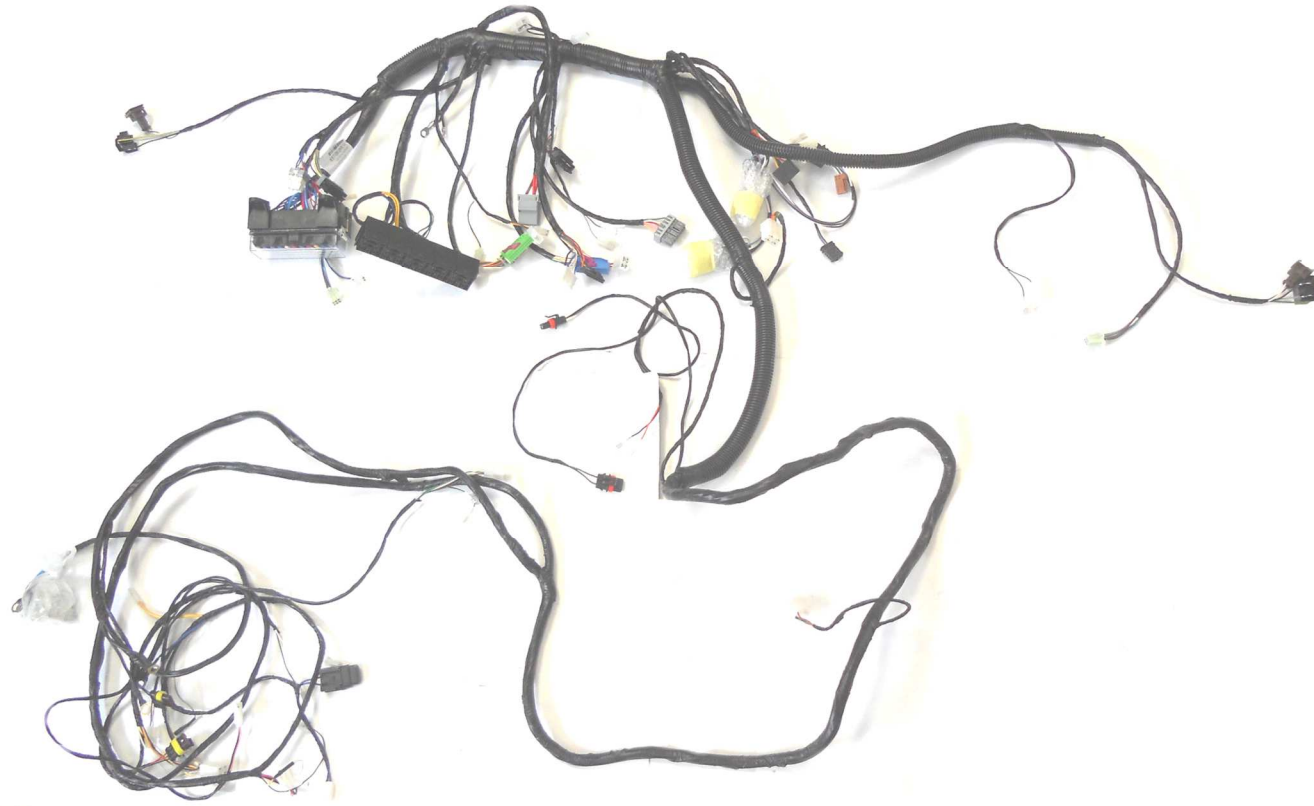

12 11 10 9 8 7 6 5 4 3 2 1

1—ACC autoradio MGS

2—Lève-vitre gauche / droit

3—Anti-brouillard / veilleuse

4—Phares / Code klaxon

5—Démarreur / Préchauffage

6—Options

7—Combiné

8—Radio / Warning / Allume-cigare /  
Plafonnier / MGS

9—Essuie-glace / Ventilateur chauffage

10—EV Stop / Alternateur

11—Combiné

12—Recul / Stop

<b>Repère</b>	<b>Q.TE</b>	<b>Référence</b>	<b>Désignation</b>
1	1	00452347	FAISCEAU HABITACLE
2	1	00450888	RELAIS PUISSANCE

	<b>350</b>	<b>FAISCEAUX HABITACLE</b>	<b>DOCKER</b>
-------------------------------------------------------------------------------------	------------	----------------------------	---------------

1





<b>Repère</b>	<b>Q.TE</b>	<b>Référence</b>	<b>Désignation</b>
1	1	00452348	FAISCEAU PLAFONNIER

	<b>360</b>	<b>FAISCEAU PLAFONNIER</b>	<b>DOCKER</b>
-------------------------------------------------------------------------------------	------------	----------------------------	---------------

1

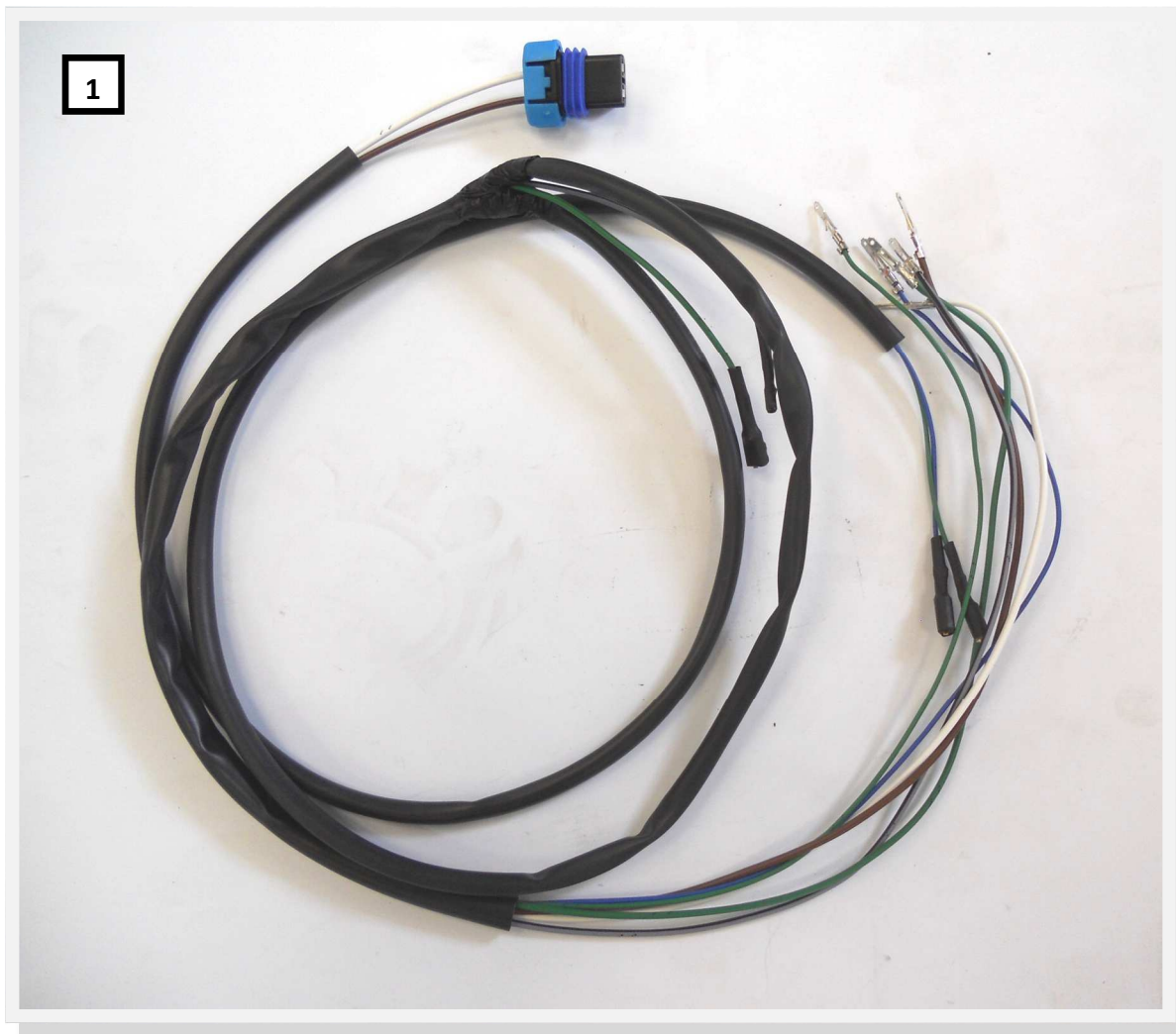

Repère	Q.TE	Référence	Désignation
1	1	00452345	FAISCEAU PORTE D&G

	370	FAISCEAU PORTE D&G	DOCKER
-------------------------------------------------------------------------------------	-----	--------------------	--------

L'acceptation de nos traites ne constituent ni novation, ni dérogation.

Le refus d'acceptation de nos traites ou le défaut de paiement d'un effet à son échéance rend immédiatement exigible l'intégralité de notre créance sans mise en demeure préalable. Toute facture non réglée à la date fixée pour son paiement fera l'objet d'une majoration systématique de 1.5% par mois de retard jusqu'au jour du règlement définitif.

A titre de clause pénale, une indemnité de 15% sur les factures non réglées nous sera due.

Le montant des acomptes éventuellement versés nous seront acquis à titre de dommages et intérêts.

Toutes contestations qui pourraient survenir à l'occasion de l'interprétation ou de l'exécution des présentes conventions ainsi que du non-paiement des factures sera du ressort du tribunal du commerce de la Roche sur Yon, qui a compétence exclusive, même en cas d'appel en garantie ou de pluralité de défendeur et ce, non obstant toute clause contraire.

Clause de réserve de propriété (Loi de mai 1980, N°80335). Le vendeur se réserve la propriété des marchandises jusqu'à l'encaissement intégral du prix.

BELLIER AUTOMOBILES—SAS AU CAPITAL DE 2 500 000€

	<b>390</b>	<b>FONCTIONNEMENT COMMANDE DE PIECES</b>	<b>DOCKER</b>
-----------------------------------------------------------------------------------	------------	----------------------------------------------	---------------

Conditions exclusives aux distributeurs :

***Commande de stock***

- ⇒ Une remise de 45% sera accordée sur toute commande d'un montant supérieur à 500€ Net HT (sauf pièces moteur Yanmar et Lombardini)
- Cette commande sera expédiée franco de port et d'emballage, sauf en cas de pièces trop volumineuses tels que carrosserie, châssis complet, palette de batteries ou pneumatiques (taxation transport rapport poids/volume).
  - Délai de traitement de 3 jours ouvrés selon disponibilité de la marchandise

***Commande de dépannage***

- ⇒ Une remise de 40% sera accordée pour toute autre commande de dépannage entre 100€ et 400€ Net HT + transport et emballage à la charge du destinataire
- ⇒ Une remise de 30% sera accordée pour toute commande de dépannage inférieure à 100€ Net HT + transport et emballage à la charge du destinataire
- ⇒ Délai du traitement des commandes de dépannage: 24h à 48h selon disponibilité des pièces
- ⇒ Toute commande express passée après 11h ne sera traitée qu'à partir du lendemain.

