

Repère	Q.TE	Référence	Désignation
1	1	02300903	VOLANT B8 STANDARD
2	1	00300943	COLONNE DIRECTION + NEIMAN
3	1	00500900	LOGO VOLANT BELLIER
4	1	00102923	STRUCTURE SOUS PDB
5	1	00300951	RALLONGE COLONNE DIRECTION
6	1	00300972	SOUFFLER RALLONGE COLONNE
7	2	00300962	COQUILLE CREMAILLERE
8	1	00300934	CHAPE SUPPORT ROTULE
9	1	00300970	BIELLETTTE COURTE NUE
10	2	00300903	BIELLETTTE LONGUE NUE
11	1	00200961	LEVIER DE DIRECTION AVEC BAGUES
12	2	00300940	ROTULE CREMAILLERE A OEIL
13	3	00300912	ROTULE CREMAILLERE
14	1	00300932	CREMAILLERE DIRECTION
15	1	00300959	PLATINE SERRAGE SIMPLE
16	1	00300958	PLATINE SERRAGE DOUBLE
17	1	00300947	TIRANT DE DIRECTION G
18	1	00300948	TIRANT DE DIRECTION D

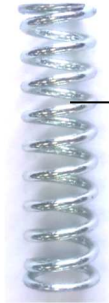

1

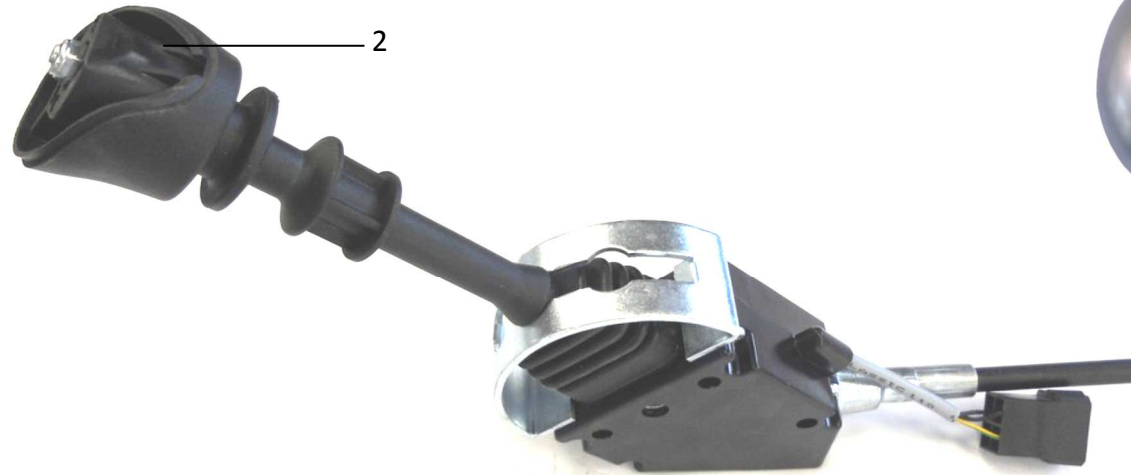

2

3

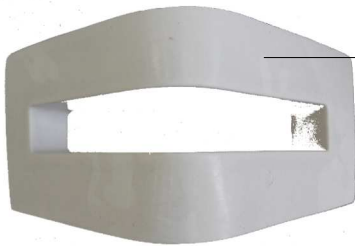







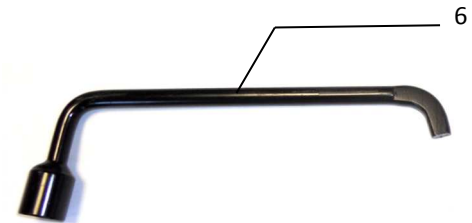
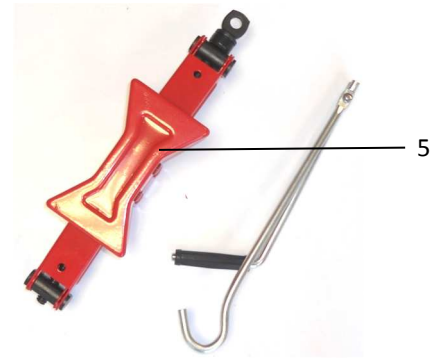
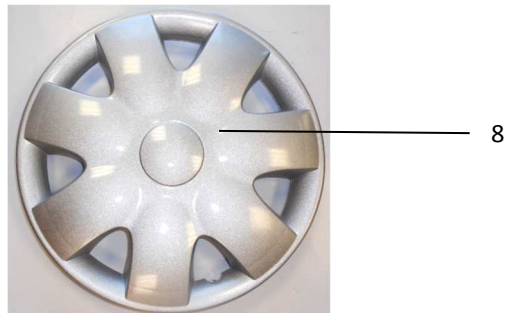
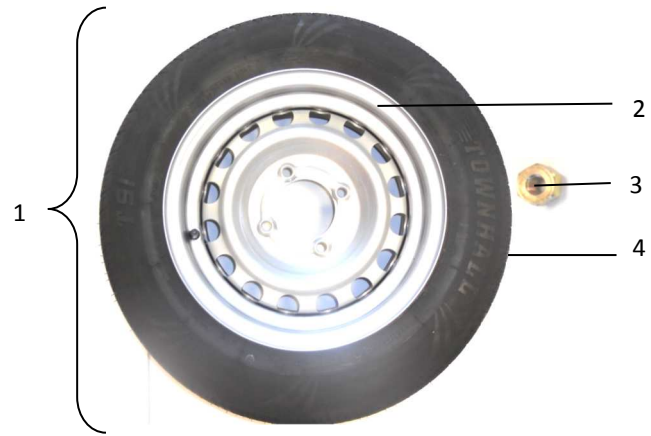



4

Repère	Q.TE	Référence	Désignation
1	1	00201512	RESSORT CABLE INVERSEUR
2	1	00201510	BOITIER INVERSEUR MARCHE
3	1	02201501	POMMEAU INVERSEUR
4	1	00102926	SUPPORT INVERSEUR

	220	BOITIER INVERSEUR	DOCKER
---	------------	--------------------------	---------------







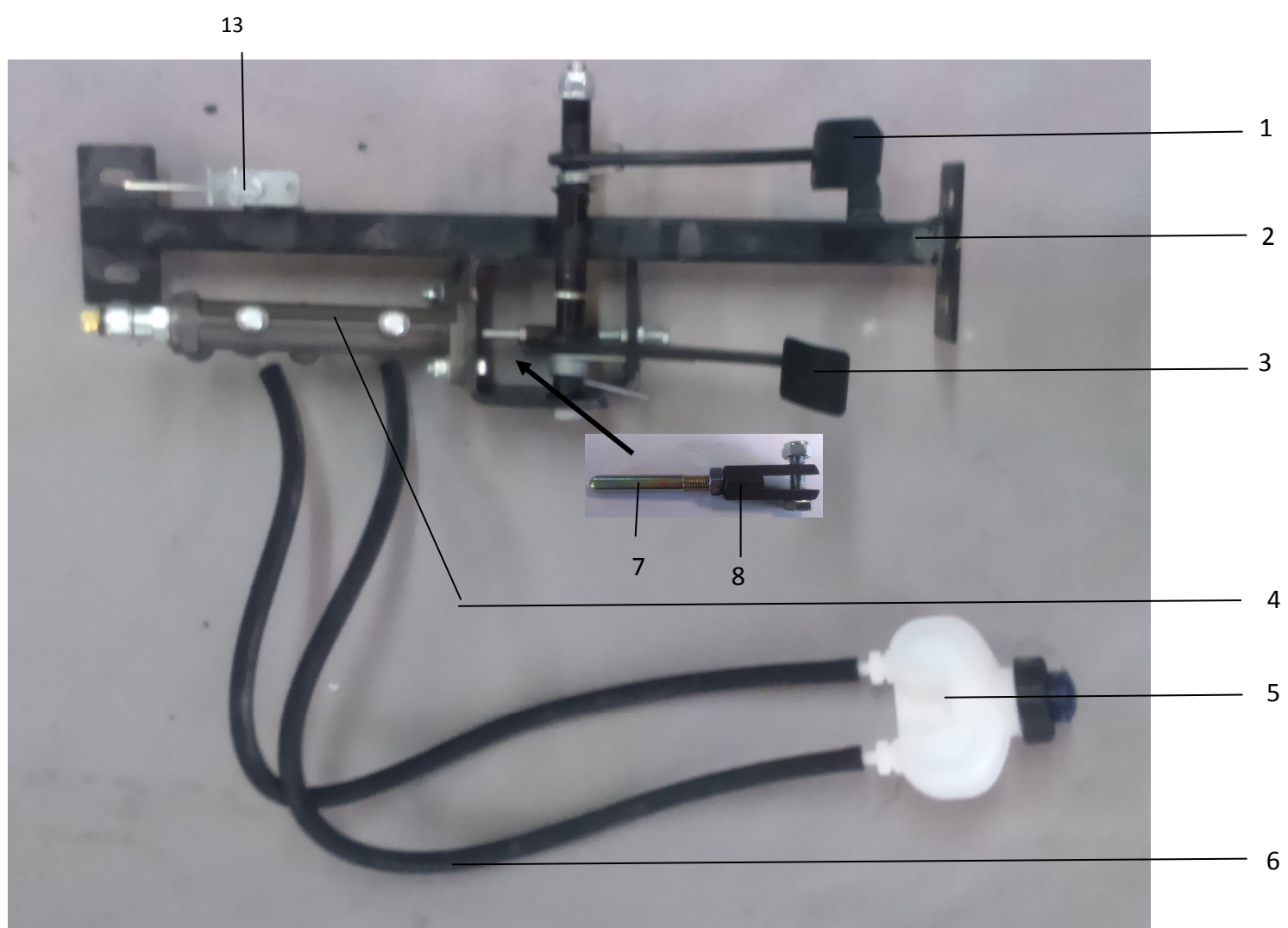





Repère	Q.TE	Référence	Désignation
1	1	01303112	ROUE COMPLETE 145 80 R13
2	1	01303122	JANTE TOLE
3	4	00993101	ECROU ROUE
4	1	01303123	PNEU 145 80 R13
5	1	00303129	CRIC
6	1	00303106	CLE
7	1	00303122	BOMBE ANTI-CREVAISON
8	1	00753108	ENJOLIVEUR 13'

- 1 
- 3 
- 7 
- 8 
- 9 
- 10 
- 11 
- 12 
- 13 
- 14 



Repère	Q.TE	Référence	Désignation
1	1	00502014	PEDALE ACCELERATEUR
2	1	00502010	SUPPORT PEDALIER
3	1	00502012	PEDALE DE FREIN
4	1	00702040	MAITRE CYLINDRE & PIPETTE
5	1	00352003	RESERVOIR LIQUIDE DE FREIN
6	2	00702042	TUBE TRESSE MAITRE CYLINDRE
7	1	00502015	TIGE POUSSEE
8	1	00702066	CHAPE PEDALE FREIN
9	1	00502002	RESSORT PEDALE DE FREIN
10	1	00502013	RESSORT PEDALE ACCELERATEUR
11	1	00702059	COIFFE-PEDALE
12	1	00452003	CONTACTEUR FEU STOP
13	1	00702043	SUPPORT RESERVOIR LIQUIDE
14	1	00703649	JOINT CUIVRE FLEXIBLE FREIN

- 11 
- 17 
- 18 
- 21 
- 22 
- 23 
- 8 
- 25 
- 26 
- 27 

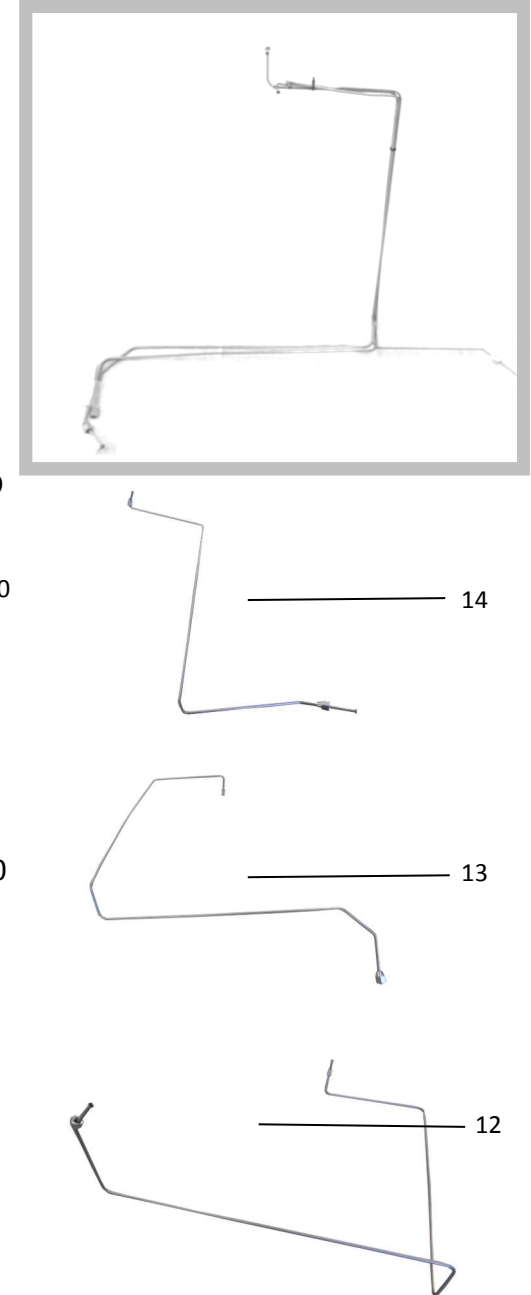
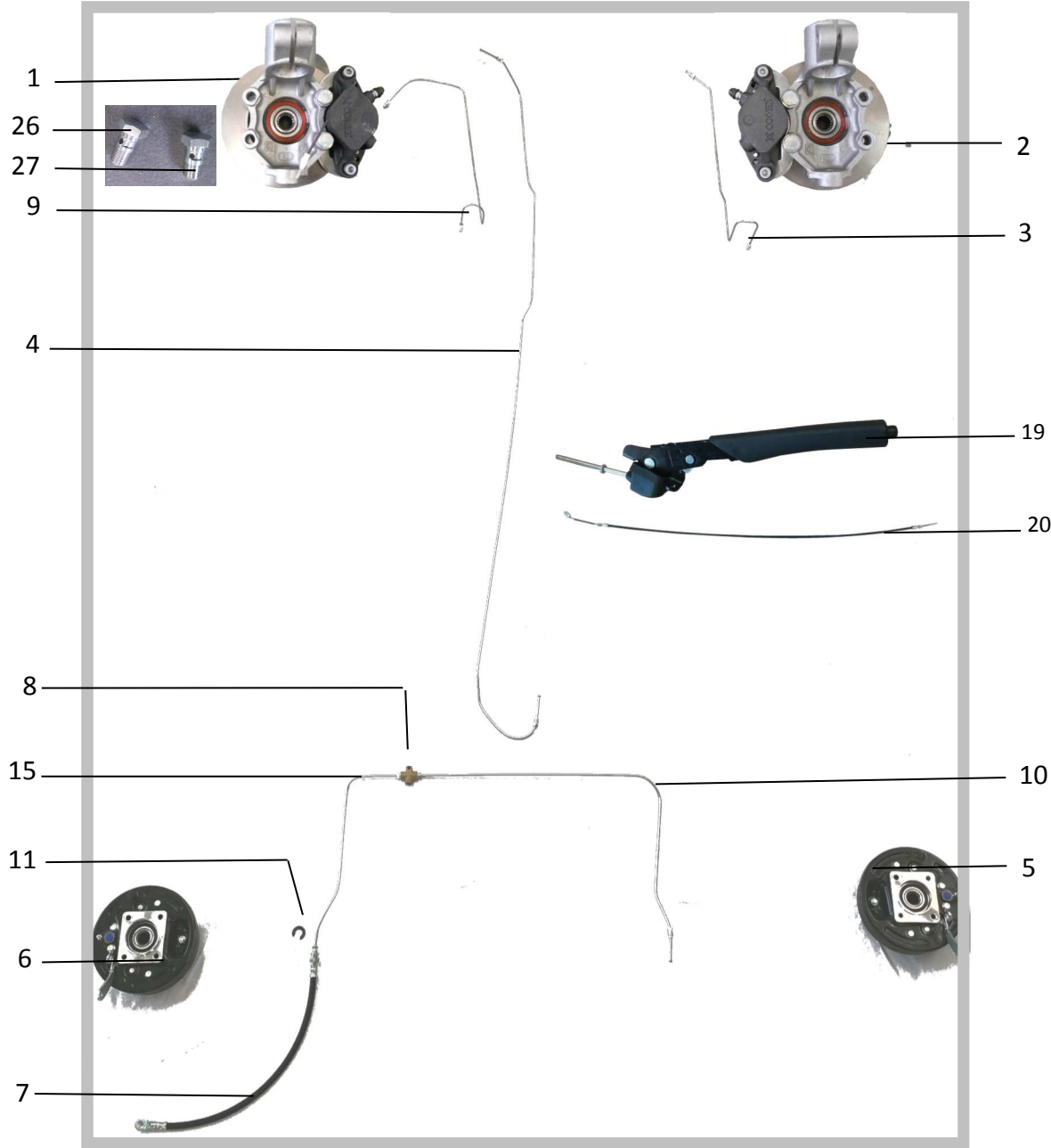

Repère	Q.TE	Référence	Désignation
1	1	00703606	FREIN DISQUE AV G COMPLET
2	1	00703607	FREIN DISQUE AV D COMPLET
3	1	00702069	TUBE FREIN RIGIDE AV D
4	1	00702064	TUBE FREIN RIGIDE
5	1	00703653	FREIN TAMBOUR AR D COMPLET
6	1	00703654	FREIN TAMBOUR AR G COMPLET
7	4	00702020	FLEXIBLE FREIN
8	1	00702051	REPARTITEUR T UT-DV-OP
9	1	00702049	TUBE FREIN RIGIDE AV G
10	1	00702052	TUBE FREIN RIGIDE AR D
11	1	00992008	AGRAFE FLEXIBLE FREIN
12	1	00702070	TUBE FREIN RIGIDE HAUT INTER
13	1	00702071	TUBE FREIN RIGIDE HAUT GAUCHE
14	1	00702072	TUBE FREIN RIGIDE HAUT DROIT
15	1	00702053	TUBE FREIN RIGIDE AR G
17	1	00703674	ARBRE MOYEU AV
18	2	00999953	AGRAFE VERTE OU JAUNE
19	1	00702023	LEVIER DE FREIN A MAIN
20	2	00652009	CABLE FREIN A MAIN
21	9	00703649	JOINT CUIVRE FLEXIBLE DE FREIN
22	2	00704200	PATTE FIXATION AGRAFE FLEXIBLE
23	1	00702060	PALONNIER FREIN MAIN
25	4	00992001	RONDELLE PLASTIQUE FLEXIBLE
26	2	00992010	VIS FLEXIBLE FREIN AR 10/1.25
27	2	00992009	VIS FLEXIBLE FREIN AV 10/1.00

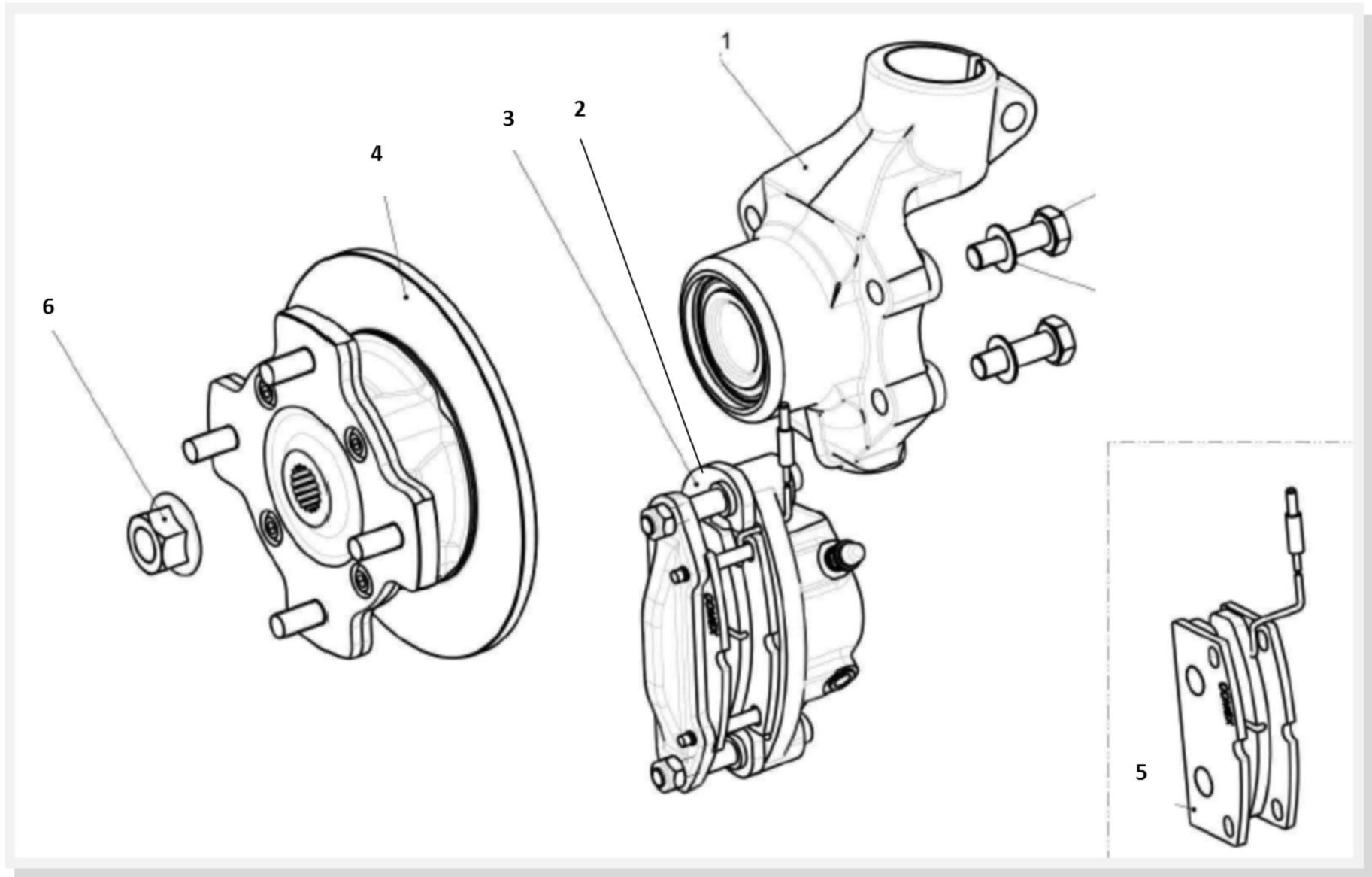

Repère	Q.TE	Référence	Désignation
1	2	00703609	PIVOT ALU FREIN A DISQUE D OU G
2	1	00703676	ETRIER FREIN AV G
3	1	00703613	ETRIER FREIN AV D
4	2	00703610	DISQUE FREIN
5	1	00703614	PLAQUETTE FREIN (JEU 4)
6	1	00999933	ECROU FREIN MOYEU TRANSMISSION

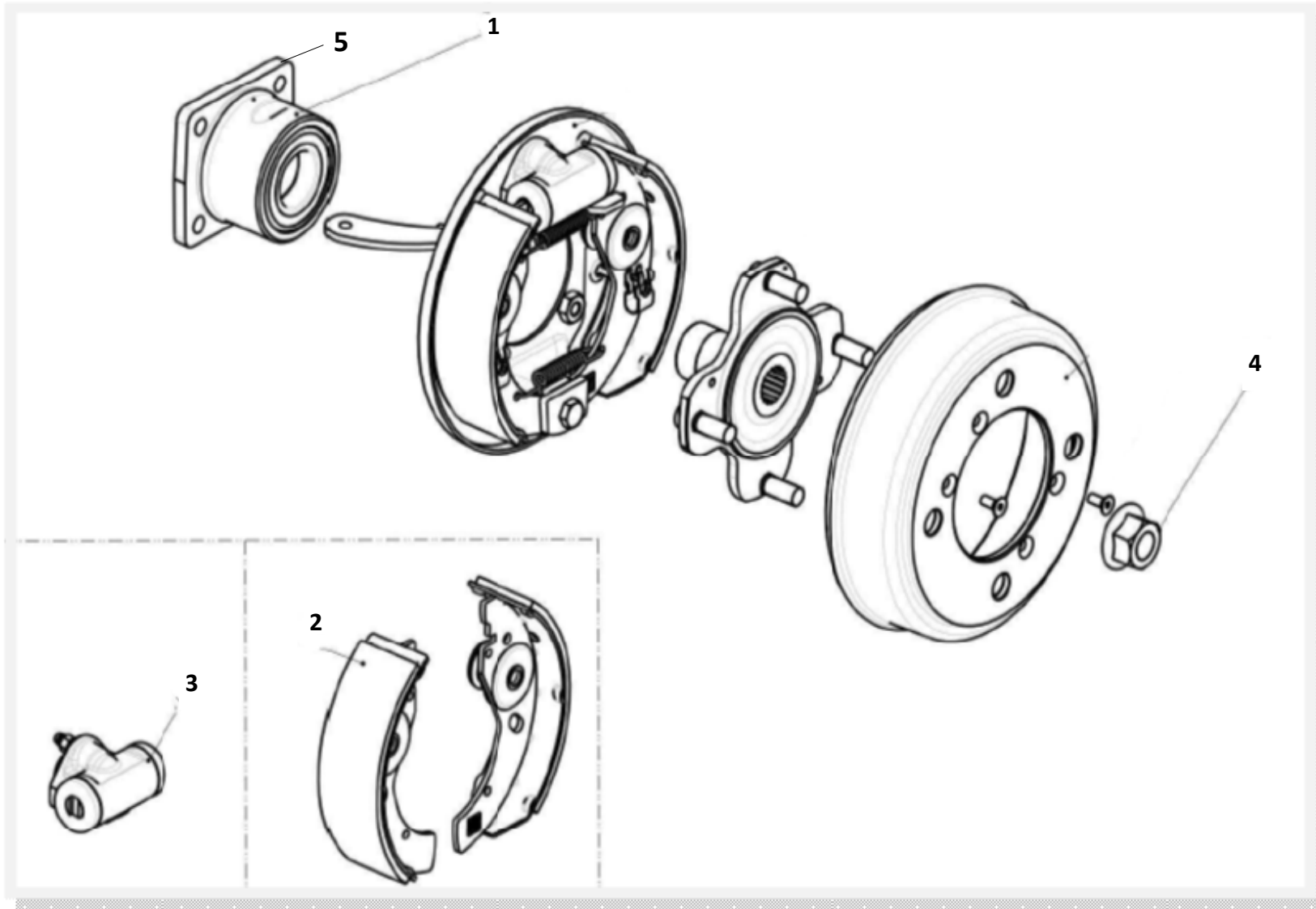

Repère	Q.TE	Référence	Désignation
1	1	00703655	ROULEMENT MOYEU AR
2	1	00703616	MACHOIRE DE FREINS (JEU DE 4)
3	1	00703615	CYLINDRE DE ROUE AR
4	1	00999933	ECROU FREIN MOYEU TRANSMISSION
5	1	00703656	PORTE ROULEMENT MOYEU

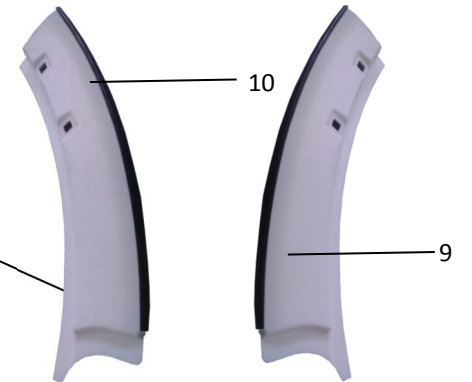
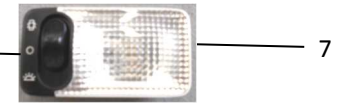
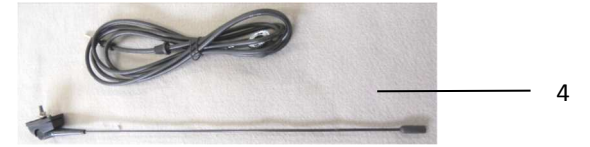
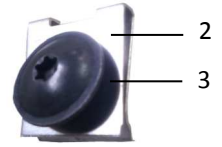
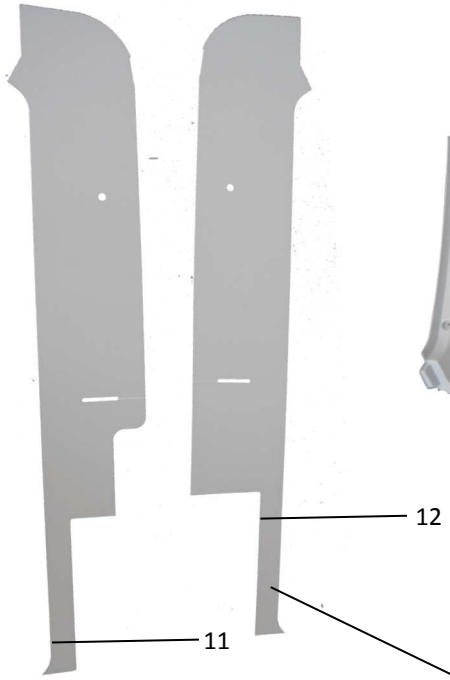

Repère	Q.TE	Référence	Désignation
1	1	00502968	PORTE-DOCUMENTS
2	4	00992011	AGRAFE CLIP
3	4	00999962	VIS 5X16 TB TORX
4	1	00450606	ANTENNE TOIT
5	1	00502949	PARE-SOLEIL G
6	1	00502948	PARE-SOLEIL D
7	1	00450881	PLAFONNIER
8	2	00500138	POIGNEE MAINTIEN
9	1	00502967	JAMBAGE AV D
10	1	00502966	JAMBAGE AV G
11	1	00502974	JAMBAGE AR D
12	1	00502975	JAMBAGE AR G
13	2	00502965	TALONNETTE D & G
14	1	00504205	PATTE SUPPORT PORTE-DOCUMENTS

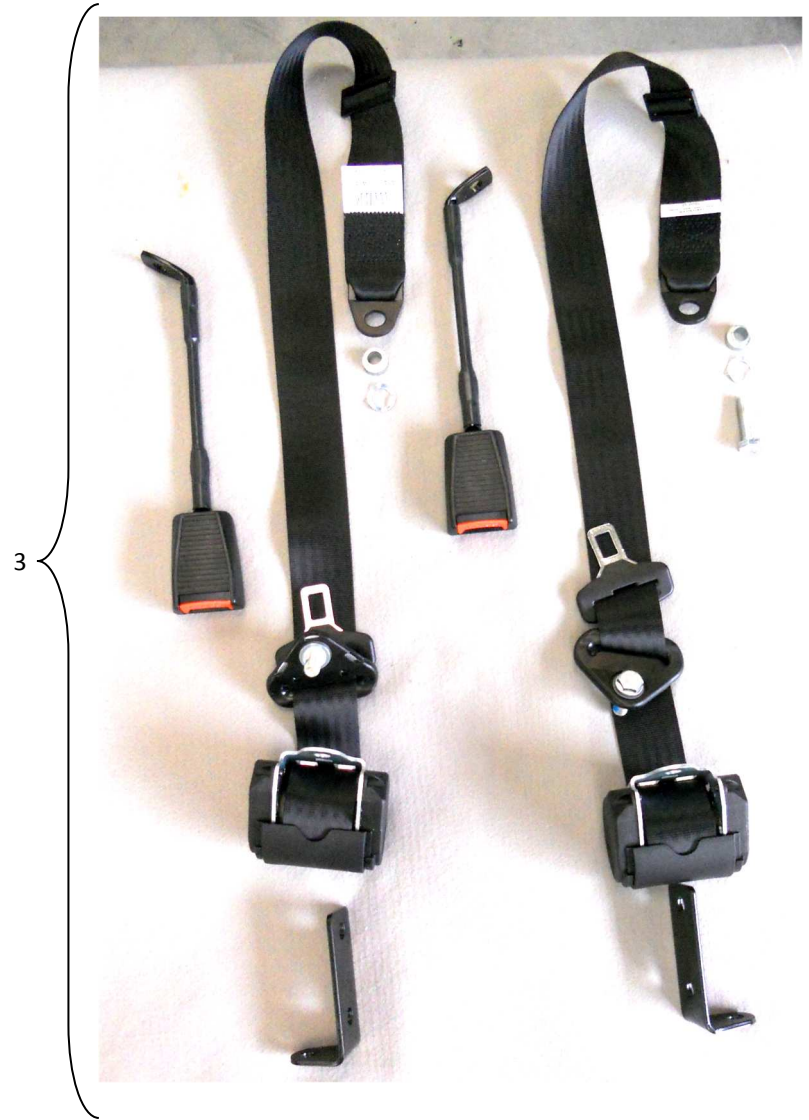

Repère	Q.TE	Référence	Désignation
1	1	01553514	SIEGE D CUIR-TISSU
2	1	01553515	SIEGE G CUIR-TISSU
3	1	00553525	CEINTURE DE SECURITE (PAIRE)

	290	SIEGE	DOCKER
---	------------	--------------	---------------



20



2

3



4



5



17



15



18



11



10

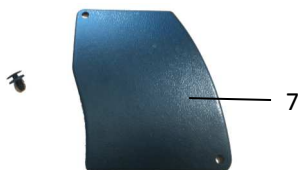

7

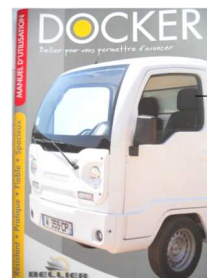

19



9

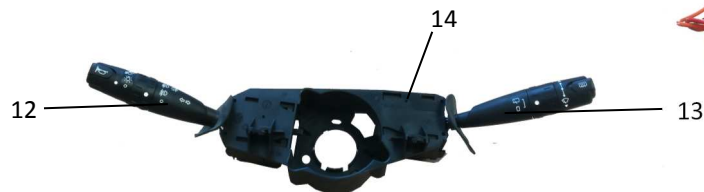

14

12

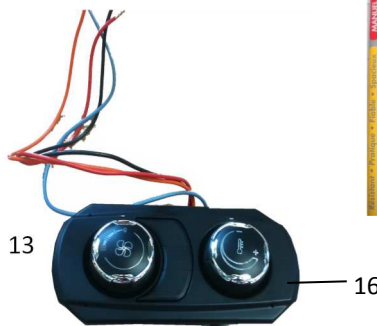

16



1



8



6

Repère	Q.TE	Référence	Désignation
1	2	00451331	INTERRUPTEUR LEVE-VITRE
2	1	00500344	CASQUETTE COMBINE
3	1	00455209	COMBINE
4	1	00450850	CACHE AUTORADIO
5	1	00450615	AUTORADIO CD MP3 USB
6	2	00504209	PATTE FIXATION PDB
7	1	00500345	TRAPPE FUSIBLE
8	1	00451330	INTERRUPTEUR FEU DE DETRESSE
9	1	00502955	FILET LATERAL COFFRE
10	1	00450827	PRISE 12V LUXE
11	1	00500346	JEUX PAD PDB
12	1	00453257	COMMUTATEUR ECLAIRAGE
13	1	00453258	COMMUTATEUR EG
14	1	00453259	SUPPORT COMMUTATEUR
15	1	02300903	VOLANT STANDARD
16	1	00501613	PLATINE CDE CHAUFFAGE
17	1	00500342	PLANCHE BORD
18	1	00500900	LOGO VOLANT BELLIER
19	1	01965324	NOTICE UTILISATION DOCKER V2
20		--	ANCIEN COMBINE REMPLACE PAR LA REFERENCE 00455209

- 3 
- 4 
- 1 
- 7-8 
- 10 
- 9 
- 6 
- 2 
- 5 
- 12 
- 11 



- 14
- 15
- 6
- 1

Repère	Q.TE	Référence	Désignation
14	1	00104113	CELLULE POLYESTER LONGUE & PORTES
1	4	00104103	CHARNIERE PORTE CELLULE
2	4	00500325	ENTRETOISE PLASTIQUE 6MM
3	1	00104104	BUTEE INF PORTE CELLULE
4	1	00104105	BUTEE SUP PORTE CELLULE
5	4	00104106	CONTRE PLAQUE PORTE CELLULE
6	1	00104102	SERRURE A CLE
7	1	00104107	FICHE RESSORT INF D60 INOX
8	1	00104108	FICHE RESSORT SUP G60 INOX
9	8	00104109	BUTEE CELLULE POLYESTER UT
10	2	00104110	CACHE-FICHE RESSORT G60 INOX
11	3.25	00104111	CORNIERE ALU
12	1.52	00104112	PROFIL U ALU
15	1	PRDOCCCELLPOLY 00999999	CELLULE POLYESTER DOCKER PR VISSERIE

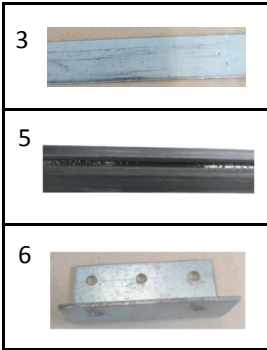

Repère	Q.TE	Référence	Désignation
1	1	00154207	BUTOIR AR DOC AVEC CELLULE
2	1	00104114	CELLULE NON LISSE POLYESTER LONGUE A
3	2	00101509	LATTE SUPPORT PROFIL DOC
6	6	00154208	CORNIERE FIXATION PROFIL DOC
5	2	00602909	PROFIL BUTOIR CELLULE
4	1	00100318	RIDEAU CELLULE
7	1	00104115	CELLULE LISSE
8	1	SECELLULELISSE	ENSEMBLE CELLULE LISSE DOCKER
9	1	SECELLULENONLISSE	ENSEMBLE CELLULE NON LISSE DOC

	320	CELLULE LISSE ET NON LISSE	DOCKER
---	------------	-----------------------------------	---------------

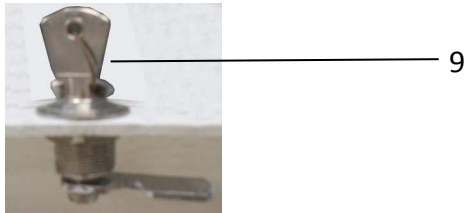

Repère	Q.TE	Référence	Désignation
3	1	00104707	KIT BENNE DOCKER
8	1	00102929	COFFRE DE BENNE
7	1	00102928	COFFRE A OUTILS
1	1	00103313	BACHE LONGUE GRISE
2	1	00103310	ENSEMBLE ARCEAU & TUBE
5	1	00105113	REHAUSSE GRILLAGEE LONGUE D
6	1	00105114	REHAUSSE GRILLAGEE LONGUE G
4	1	00105115	PARE CABINE GRILLAGEE
9	1	00104117	SERRURE A CLE COFFRE A OUTILS
10	18	00993300	ANNEAU BACHE

	330	OPTIONS	DOCKER
--	------------	----------------	---------------

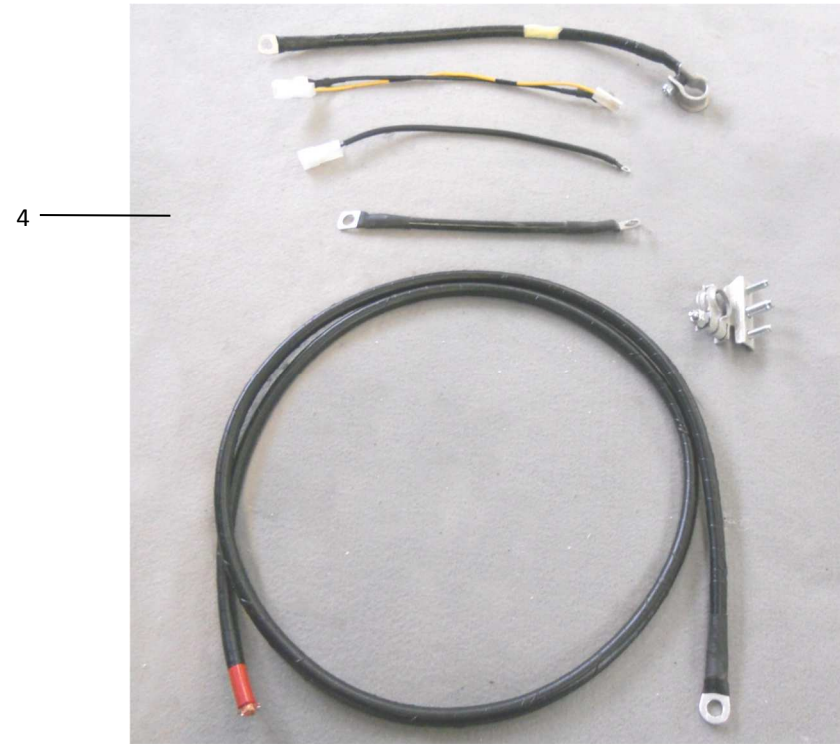

Repère	Q.TE	Référence	Désignation
1	1	00450805	BATTERIE 12V
2	1	00454207	BRIDE BATTERIE
3	1	00450887	MODULE GESTION
4	1	00452329	COMPLEMENT FAISCEAU

1

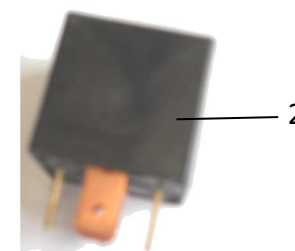
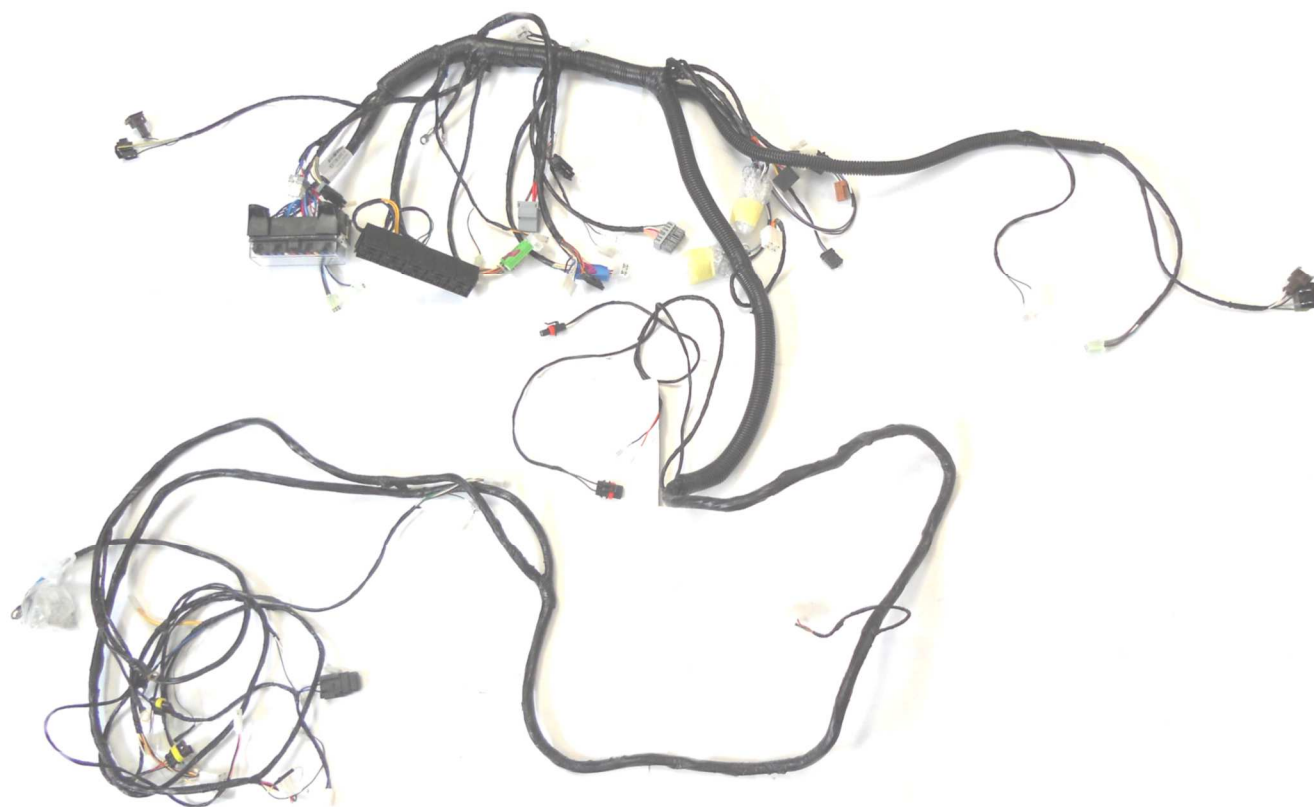

12 11 10 9 8 7 6 5 4 3 2 1

1—ACC autoradio MGS

2—Lève-vitre gauche / droit

3—Anti-brouillard / veilleuse

4—Phares / Code klaxon

5—Démarreur / Préchauffage

6—Options

7—Combiné

8—Radio / Warning / Allume-cigare /
Plafonnier / MGS

9—Essuie-glace / Ventilateur chauffage

10—EV Stop / Alternateur

11—Combiné

12—Recul / Stop

Repère	Q.TE	Référence	Désignation
1	1	00452347	FAISCEAU HABITACLE
2	1	00450888	RELAIS PUISSANCE

	350	FAISCEAUX HABITACLE	DOCKER
---	------------	----------------------------	---------------

1



Repère	Q.TE	Référence	Désignation
1	1	00452348	FAISCEAU PLAFONNIER

	360	FAISCEAU PLAFONNIER	DOCKER
---	------------	----------------------------	---------------

1

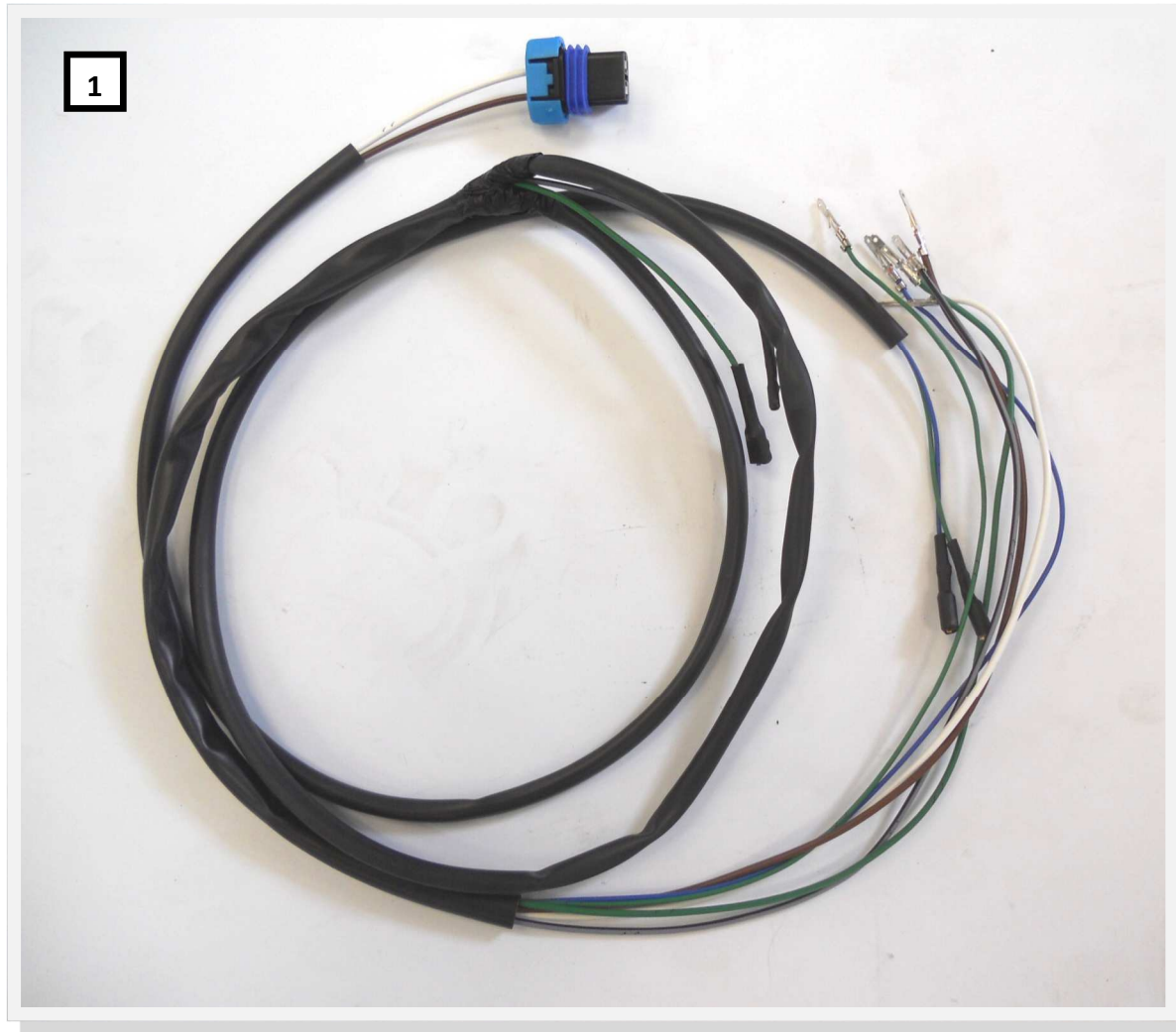

Repère	Q.TE	Référence	Désignation
1	1	00452345	FAISCEAU PORTE D&G

	370	FAISCEAU PORTE D&G	DOCKER
---	------------	-------------------------------	---------------

L'acceptation de nos traites ne constituent ni novation, ni dérogation.

Le refus d'acceptation de nos traites ou le défaut de paiement d'un effet à son échéance rend immédiatement exigible l'intégralité de notre créance sans mise en demeure préalable. Toute facture non réglée à la date fixée pour son paiement fera l'objet d'une majoration systématique de 1.5% par mois de retard jusqu'au jour du règlement définitif.

A titre de clause pénale, une indemnité de 15% sur les factures non réglées nous sera due.

Le montant des acomptes éventuellement versés nous seront acquis à titre de dommages et intérêts.

Toutes contestations qui pourraient survenir à l'occasion de l'interprétation ou de l'exécution des présentes conventions ainsi que du non-paiement des factures sera du ressort du tribunal du commerce de la Roche sur Yon, qui a compétence exclusive, même en cas d'appel en garantie ou de pluralité de défendeur et ce, non obstant toute clause contraire.

Clause de réserve de propriété (Loi de mai 1980, N°80335). Le vendeur se réserve la propriété des marchandises jusqu'à l'encaissement intégral du prix.

BELLIER AUTOMOBILES—SAS AU CAPITAL DE 2 500 000€

	390	FONCTIONNEMENT COMMANDE DE PIECES	DOCKER
---	------------	--	---------------

Conditions exclusives aux distributeurs :

Commande de stock

- ⇒ Une remise de 45% sera accordée sur toute commande d'un montant supérieur à 500€ Net HT (sauf pièces moteur Yanmar et Lombardini)
- Cette commande sera expédiée franco de port et d'emballage, sauf en cas de pièces trop volumineuses tels que carrosserie, châssis complet, palette de batteries ou pneumatiques (taxation transport rapport poids/volume).
 - Délai de traitement de 3 jours ouvrés selon disponibilité de la marchandise

Commande de dépannage

- ⇒ Une remise de 40% sera accordée pour toute autre commande de dépannage entre 100€ et 400€ Net HT + transport et emballage à la charge du destinataire
- ⇒ Une remise de 30% sera accordée pour toute commande de dépannage inférieure à 100€ Net HT + transport et emballage à la charge du destinataire
- ⇒ Délai du traitement des commandes de dépannage: 24h à 48h selon disponibilité des pièces
- ⇒ Toute commande express passée après 11h ne sera traitée qu'à partir du lendemain.