

# CATALOGUE PIECES DETACHEES—DOCKER 2016



DATE	REVISIONS	COMMENTAIRES
05/07/2016	INDICE A	CREATEUR : Anne JOLLY

## CARROSSERIE

PARE CHOC AV .....	PLANCHE 20
CALANDRE.....	PLANCHE 30
CABINE AVANT.....	PLANCHE 40
CABINE .....	PLANCHE 50
JOINTS D'ETANCHEITE .....	PLANCHE 60
VUE ARRIERE.....	PLANCHE 70
PORTE GAUCHE.....	PLANCHE 80
PORTE DROITE .....	PLANCHE 90
CHASSIS + SUSPENSION .....	PLANCHE 100
VITRAGE.....	PLANCHE 110

## GROUPE MOTEUR

MOTEUR .....	PLANCHE 120
POULIE MOTRICE .....	PLANCHE 130
POULIE RECEPTRICE .....	PLANCHE 140
SYSTÈME DE REFROIDISSEMENT .....	PLANCHE 150
FILTRATION .....	PLANCHE 160
CHAUFFAGE .....	PLANCHE 170
RESERVOIR GASOIL .....	PLANCHE 180

## SYSTÈME DE DIRECTION

SYSTÈME DE DIRECTION .....	PLANCHE 200
----------------------------	-------------

## SYSTÈME DE TRANSMISSION

BOITIER INVERSEUR.....	PLANCHE 220
ROUES.....	PLANCHE 230

## SYSTÈME DE FREINAGE

PEDALIER .....	PLANCHE 240
SYSTÈME DE FREINAGE .....	PLANCHE 250
FREINS AV G & D .....	PLANCHE 260
FREINS AR G & d.....	PLANCHE 270

## EQUIPEMENTS

HABILLAGE INTERIEUR .....	PLANCHE 280
SIEGES .....	PLANCHE 290
TABLEAU DE BORD .....	PLANCHE 300
CELLULE POLYESTER LONGUES ET PORTES .....	PLANCHE 310
CELLULE LISSE ET NON LISSE .....	PLANCHE 320
OPTIONS.....	PLANCHE 330

## FAISCEAUX ELECTRIQUES

BATTERIE + CABLAGE DE PUISSANCE + MGS .....	PLANCHE 340
FAISCEAUX HABITACLE .....	PLANCHE 350
FAISCEAUX PLAFONNIER .....	PLANCHE 360
FAISCEAUX PORTES GAUCHE ET DROITE.....	PLANCHE 370

CONDITIONS GENERALES DE VENTE .....	PLANCHE 380
FONCTIONNEMENT COMMANDE DE PIECES .....	PLANCHE 390
TARIFS PUBLICS ORDRE ALPHABETIQUE .....	PAGE 1-7

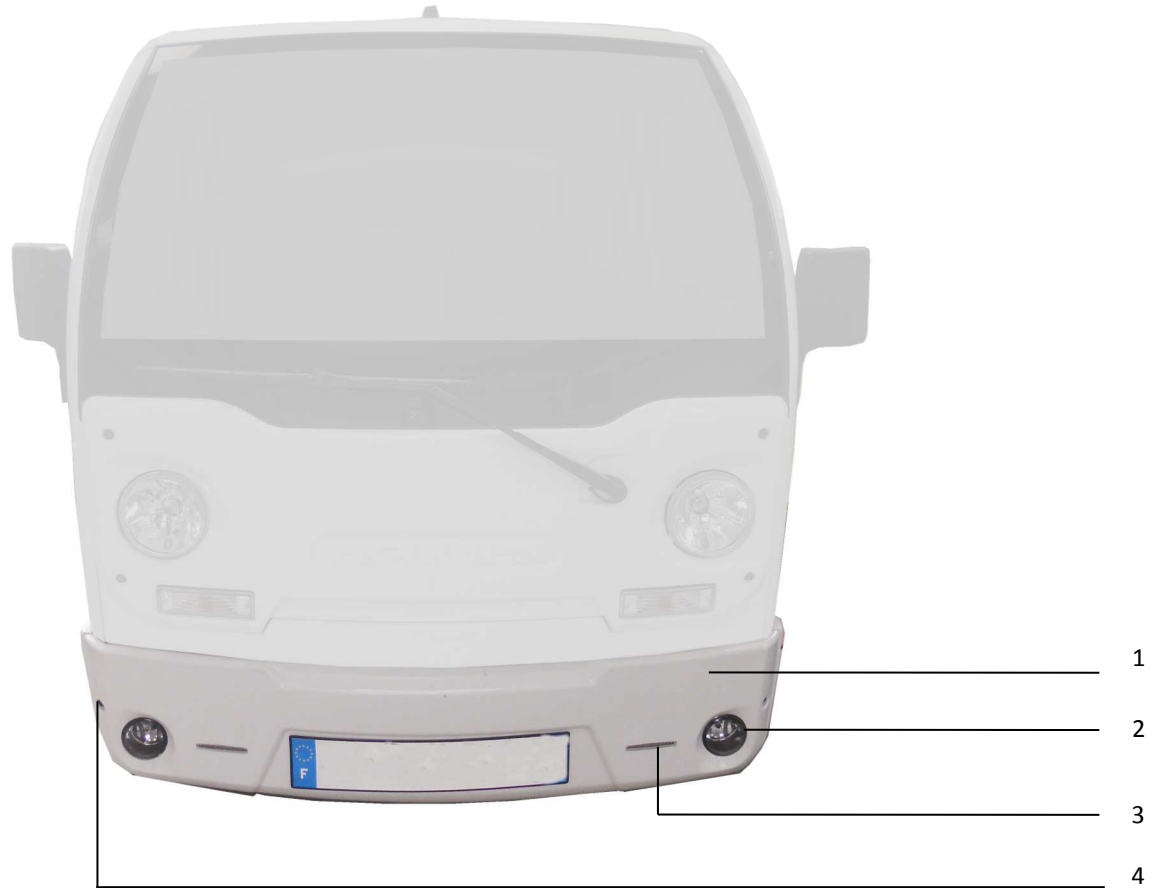
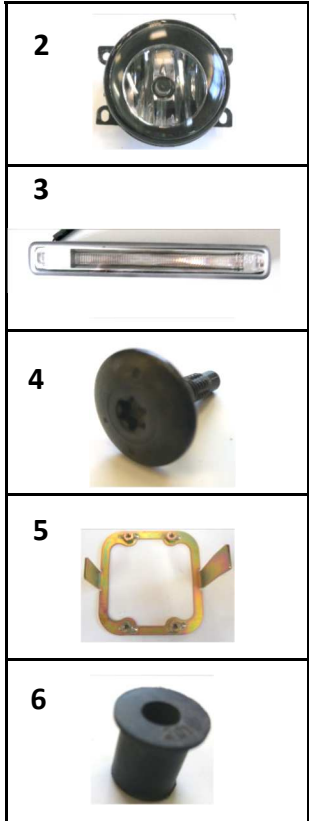

<b>Repère</b>	<b>Q.TE</b>	<b>Référence</b>	<b>Désignation</b>
1	1	00102448	PARE-CHOC
2	2	01453200	PHARE ANTIBROUILLARD
5	2	01453237	SUPPORT PHARE ANTIBROUILLARD
3	1	00453277	FEUX DIURNE (LA PAIRE)
4	2	00999963	VIS 6X20 TB TORX
6	2	00992903	WELL NUT

3



4



5



6



9



7



8



11



3

4

5

10











1

2

<b>Repère</b>	<b>Q.TE</b>	<b>Référence</b>	<b>Désignation</b>
1	1	00604904	JOINT L :1400mm
2	1	00102424	CALANDRE
3	4	00999963	VIS 6X20 TB TORX
4	2	00453256	PHARE
5	1	00453260	CLIGNOTANT AV G
10	1	00453261	CLIGNOTANT AV D
6	2	00452350	AMPOULE CLIGNOTANT AV
7	2	00353906	OBTURATEUR PHARE
8	1	00453200	PASSE-FIL OPTIQUE
9	1	00452349	FAISCEAU CLIGNOTANT
11	4	00992903	WELL NUT

	<b>30</b>	<b>CALANDRE</b>	<b>DOCKER</b>
---	-----------	-----------------	---------------

- 1 
- 2 
- 3 
- 4 
- 5 
- 7 
- 8 
- 9 

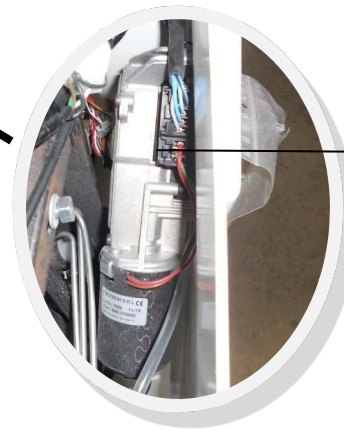
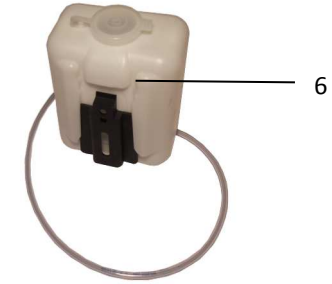

1

2

3

4

5

7

8

9

6

5

4

1

3

7

2



<b>Repère</b>	<b>Q.TE</b>	<b>Référence</b>	<b>Désignation</b>
1	2	00453254	PLATINE SUPPORT PHARE
2	2	00501620	EXTRACTEUR D'AIR
3	1	00451128	MOTEUR EG AV
4	1	00451126	BRAS EG AV
5	1	00451127	BALAI EG AV
6	1	00351100	RESERVOIR LAVE-GLACE & POMPE
7	1	00450807	AVERTISSEUR
8	1	00501101	PASSE-CLOISON LAVE-GLACE
9	1	00451132	CALE MOTEUR EG

	<b>40</b>	<b>CABINE AVANT</b>	<b>DOCKER</b>
---	-----------	---------------------	---------------

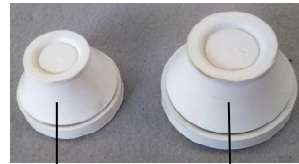

6

7



4



5



1



2



8













3

<b>Repère</b>	<b>Q.TE</b>	<b>Référence</b>	<b>Désignation</b>
1	1	00102925	CABINE BLANCHE ASSEMBLEE
2	1	00102921	ARCEAU G CABINE
3	1	00102922	ARCEAU D CABINE
4	2	00102912	PLAQUE FIXATION CABINE
5	1	00500131	DOIGT VERROUILLAGE SERRURE
6	2	00602904	PRESSE ETOUPE 40
7	1	00602902	PRESSE ETOUPE 50

	<b>50</b>	<b>CABINE</b>	<b>DOCKER</b>
---	-----------	---------------	---------------



Repère	Q.TE	Référence	Désignation
1	2	00600115	JOINT ETANCHEITE PORTE
2	1	00604904	JOINT PARE-BRISE L: 1100mm
3	2	00604904	JOINT PARE-BRISE L: 8000mm
4	1	00604904	JOINT L: 1400mm



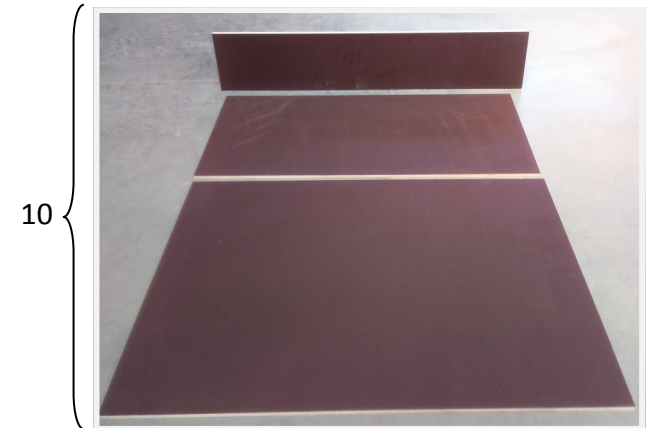
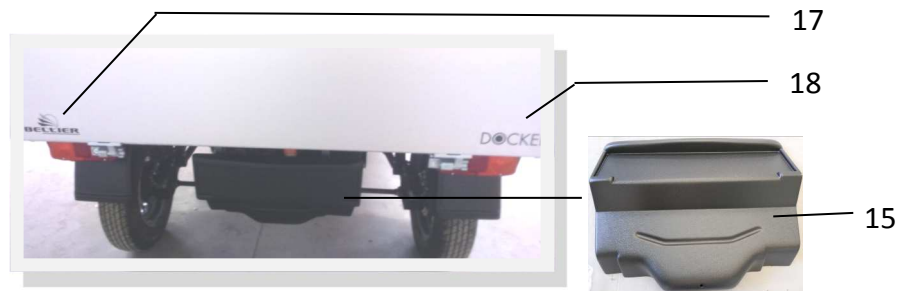





- 1 
- 2 
- 3 
- 4 
- 5 
- 6 
- 7 
- 8 
- 9 
- 21 





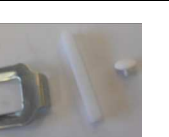





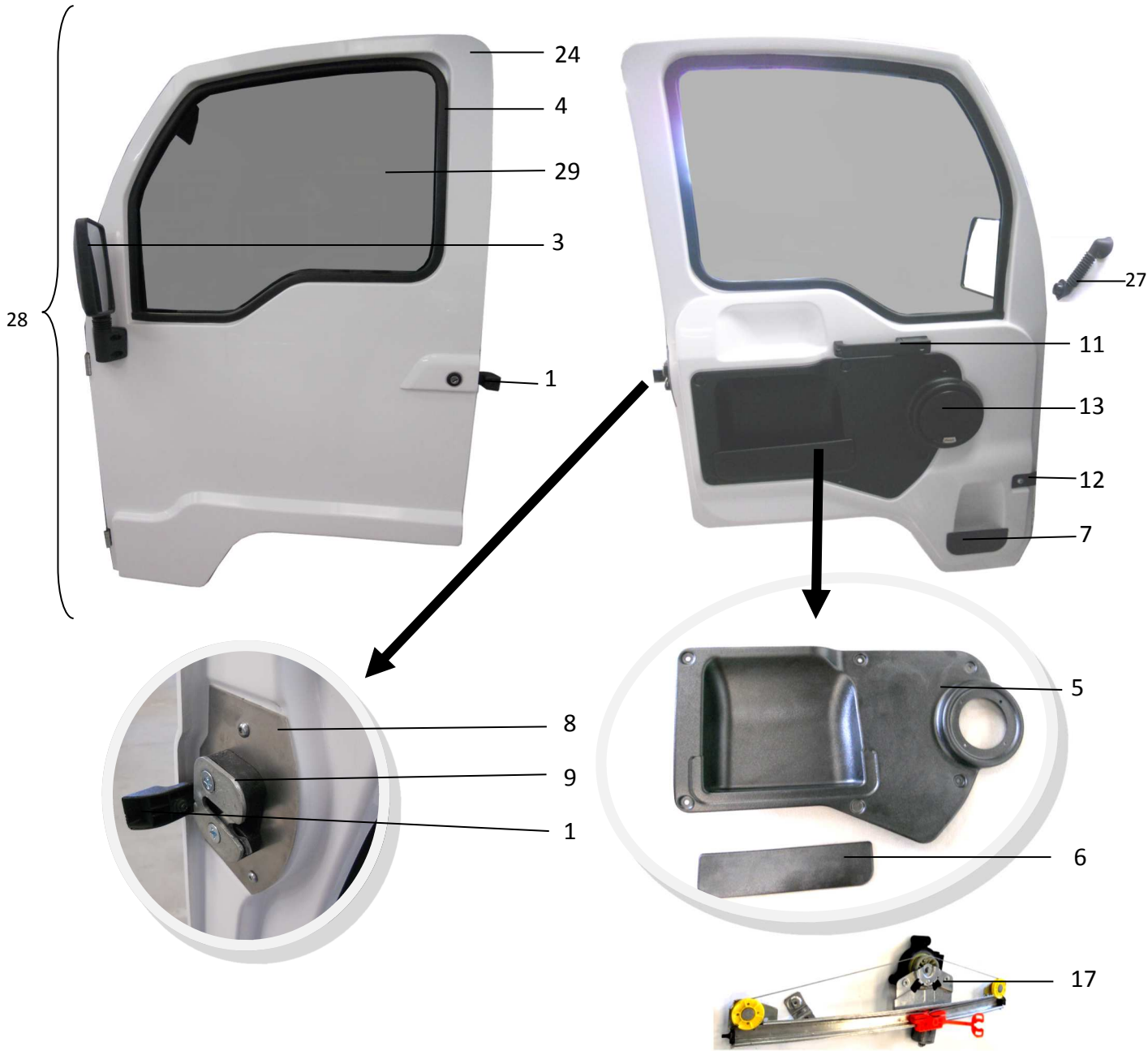

**BELLIER AUTOMOBILES**  
 e 13\*2002/24\*0649\*  
 N°SERIE:VF9 BLX Y50 A 237  
 96dB(A) - 2400 t/m

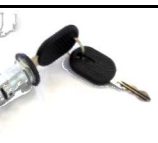
20

Repère	Q.TE	Référence	Désignation
1	2	00501621	CLAPET EXTRACTEUR D'AIR
2	1	01051705	VASE EXPANSION
4	1	00453242	FEU AR-D
3	1	00453243	FEU AR-G
5	2	00453238	AMPOULE CLIGNOTANT AR
6	2	01453221	AMPOULE FEU STOP & POSITION
7	1	00100213	GARDE-BOUE AR G
8	1	00100212	GARDE-BOUE AR D
9	1	00100211	EQUERRE FIXATION GARDE BOUE
10	1	00104704	PLANCHER BOIS LONG
11	1	00104510	RIDELLES ALU D
12	6	00104513	CHARNIERE RIDELLES ALU
13	1	00104511	RIDELLES ALU G
14	1	00104512	RIDELLES ALU AR
15	1	00102443	CARTER AR PROTECTION INF
16	1	00104703	PATTE FIXATION PLANCHER PARTIE
17	1	00754502	MONOGRAMME « BELLIER »
18	1	00754503	MONOGRAMME « DOCKER »
19	1	00104704	PLANCHER BOIS LONG
20	1	001001B6	PLAQUE CONSTRUCTEUR

- 1 
- 9 
- 11 
- 18 
- 19 
- 20 
- 21 
- 22 
- 23 



- 15 
- 14 
- 3 
- 8 
- 12 
- 26 
- 7 
- 13 
- 25 



Repère	Q.TE	Référence	Désignation
1	1	001001A3	BOUTON SERRURE G
3	1	001001B3	RETROVISEUR EXT G
4	1	00600116	JOINT COULISSE LECHEUR PORTE
5	1	00502969	GARNITURE PORTE G
6	1	00502971	BANDEAU VIDE POCHE G
7	1	00502973	BANDEAU PORTE-BOUTEILLE D&G
8	1	00100171	PLATINE FIXATION MECANISME
9	1	00100168	GACHE PORTE G
11	1	00500118	POIGNEE PORTE INT G
12	1	00100169	SANGLE ARRET PORTE
13	1	01450609	HAUT-PARLEUR (PAIRE)
14	1	00500127	BARILLET PORTE D&G
15	1	00100161	SERRURE PORTE G
17	1	01450103	LEVE-VITRE ELECTRIQUE G
18	1	00600102	JOINT GLISSIERE VITRE
19	1	00100300	COULISSE AR G
20	1	00500128	CLIP BARILLET PORTE
21	1	00100306	SUPPORT COULISSE AR G
22	1	00100134	CHARNIERE PORTE D&G
23	1	001001A6	TRINGLE PORTE
24	1	SEPORTENUEDOCKG	PORTE NUE G
25	1	00500129	LIAISON BARILLET PORTE
26	1	00100170	PLATINE FIXATION SANGLE
27	1	00502300	SOUFFLET PASSE-FAISCEAU
28	1	SEPORTEGDOCK2	PORTE COMPLETE G
29	1	01803705	GLACE PORTE G

- 1
- 9
- 11
- 18
- 19
- 20
- 21
- 22
- 23

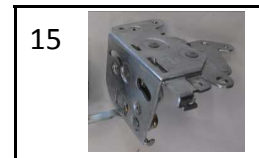
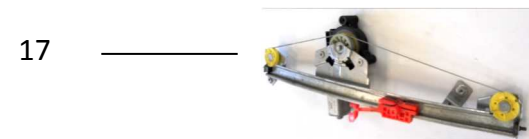
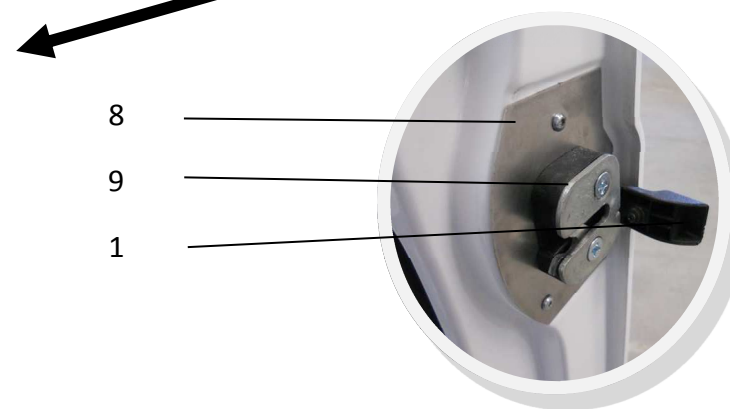
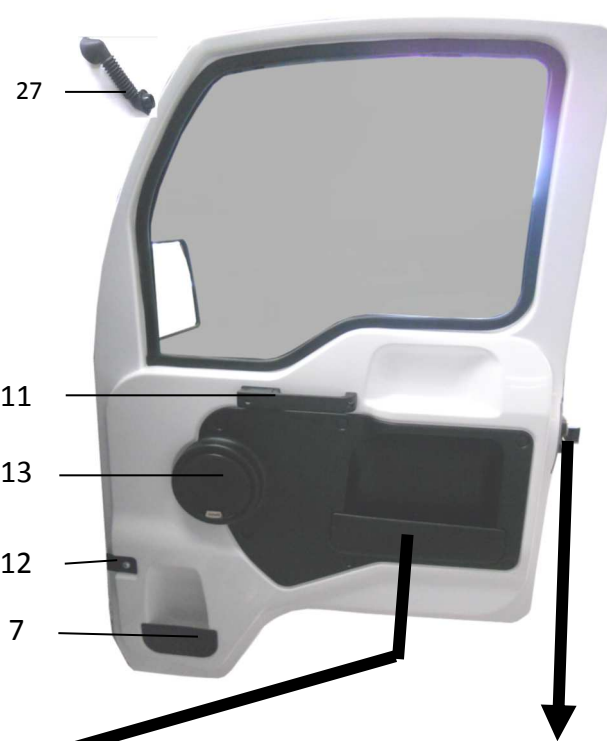
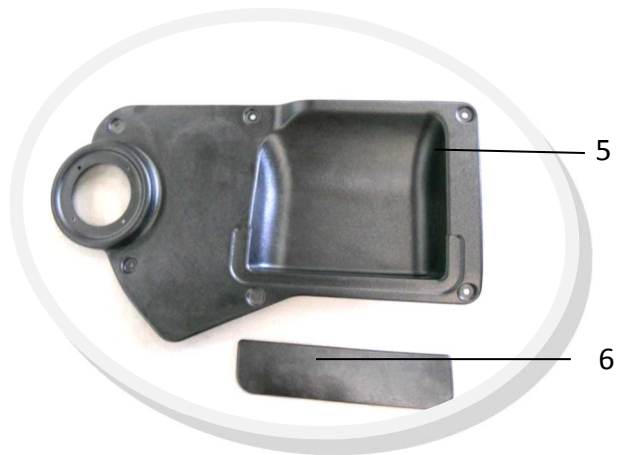
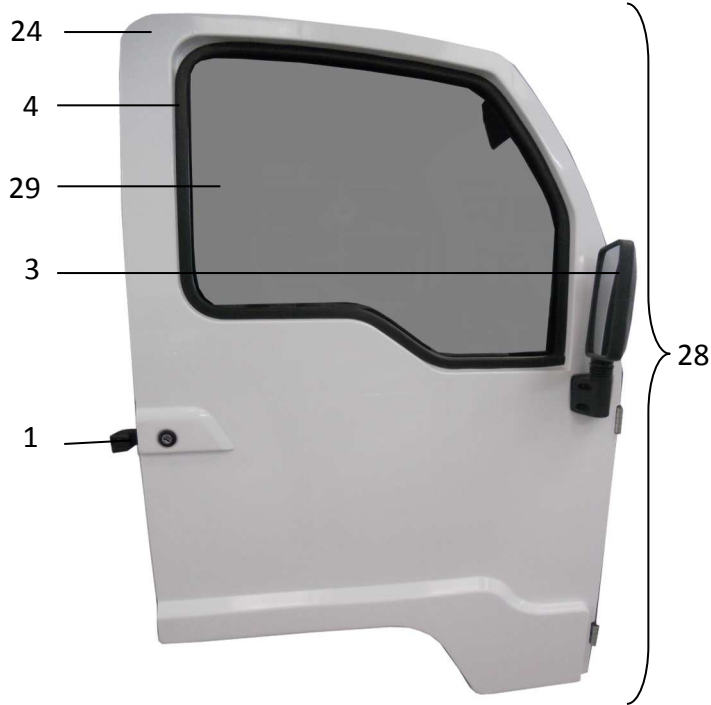

Repère	Q.TE	Référence	Désignation
1	1	001001A4	BOUTON SERRURE D
3	1	001001B2	RETROVISEUR EXT D
4	1	00600116	JOINT COULISSE LECHEUR PORTE
5	1	00502970	GARNITURE PORTE D
6	1	00502972	BANDEAU VIDE POCHE D
7	1	00502973	BANDEAU PORTE-BOUTEILLE D&G
8	1	00100171	PLATINE FIXATION MECANISME
9	1	00100167	GACHE PORTE D
11	1	00500117	POIGNEE PORTE INT D
12	1	00100169	SANGLE ARRET PORTE
13	1	01450609	HAUT-PARLEUR (PAIRE)
14	1	00500127	BARILLET PORTE D&G
15	1	00100160	SERRURE PORTE D
17	1	01450102	LEVE-VITRE ELECTRIQUE D
18	1	00600102	JOINT GLISSIERE VITRE
19	1	00100301	COULISSE AR D
20	1	00500128	CLIP BARILLET PORTE
21	1	00100307	SUPPORT COULISSE AR D
22	1	00100134	CHARNIERE PORTE D&G
23	1	001001A6	TRINGLE PORTE
24	1	SEPORTENUEDOCKD	PORTE NUE D
25	1	00500129	LIAISON BARILLET PORTE
26	1	00100170	PLATINE FIXATION SANGLE
27	1	00502300	SOUFFLET PASSE-FAISCEAU
28	1	SEPORTEDDOCK2	PORTE COMPLETE D
29	1	01803704	GLACE PORTE D



Repère	Q.TE	Référence	Désignation
2	2	00250511	AMORTISSEUR AV
5	2	00250512	AMORTISSEUR AR
10	1	00259901	AXE VIS BRAS AR
11	1	00103910	OBTURATEUR CHASSIS 25X25
12	1	00153900	OBTURATEUR CHASSIS 30X30
13	2	00252111	ROTULE INF DE SUSPENSION
14	1	00302113	TRIANGLE G BAGUE
15	1	00302114	TRIANGLE D BAGUE
16	1	00153012	CHASSIS
17	1	00252119	BRAS SUSPENSION BAGUE AR D
18	1	00252120	BRAS SUSPENSION BAGUE AR G

	<b>100</b>	<b>CHASSIS + SUSPENSION</b>	<b>DOCKER</b>
---	------------	-----------------------------	---------------

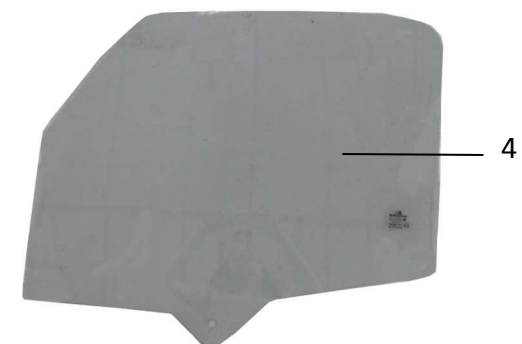
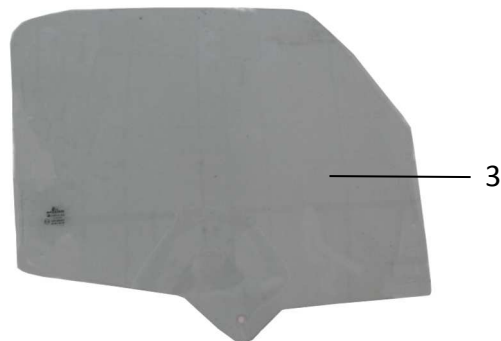
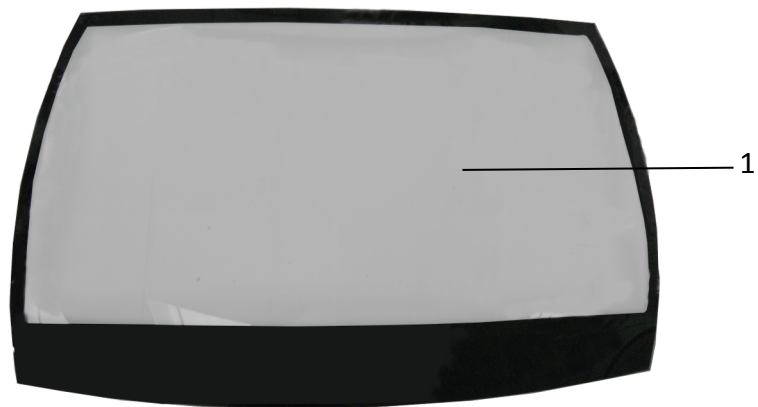

<b>Repère</b>	<b>Q.TE</b>	<b>Référence</b>	<b>Désignation</b>
1	1	00804903	PARE-BRISE
2	1	00800726	LUNETTE AR
3	1	01803704	GLACE PORTE D
4	1	01804705	GLACE PORTE G
5	1	00804003	PINCEAU APPLICATEUR PRIMAIRE

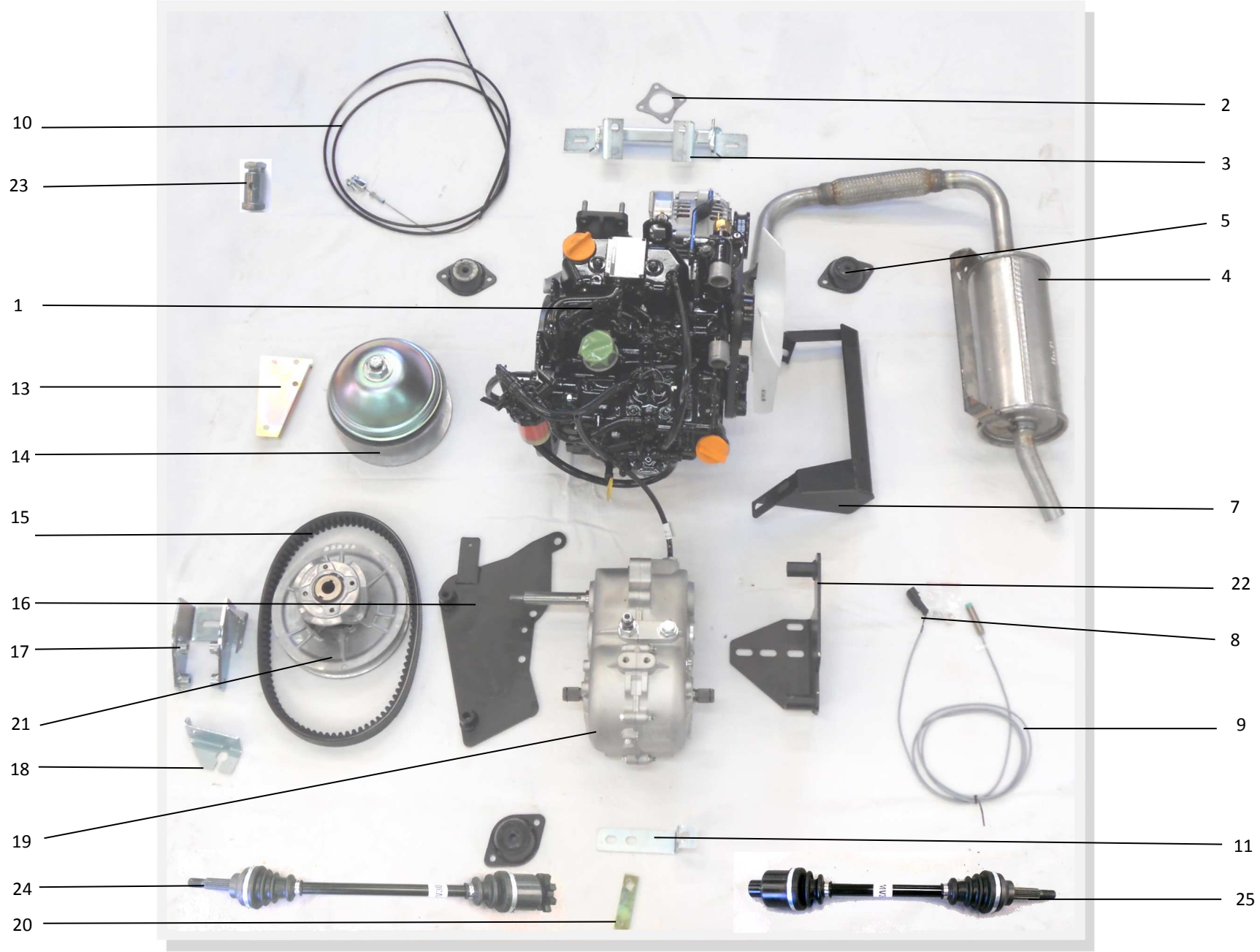



Repère	Q.TE	Référence	Désignation
1	1	000004A3	MOTEUR YAN
2	1	00000406	JOINT COLLECTEUR ECHAPPEMENT
3	1	00004203	SUPPORT MOTEUR AV
4	1	00951730	LIGNE ECHAPPEMENT
5	3	00980402	SILENTBLOC
7	1	00001711	SUPPORT RADIATEUR INF
8	1	00452344	CONNECTEUR SUPERSEAL 3 VOIES
9	1	00450818	CAPTEUR DE VITESSE
10	1	00652010	CABLE ACCELERATEUR
11	1	01154201	SUPPORT CAPTEUR DE VITESSE
13	1	000004B0	SUPPORT FILTRE A AIR
14	1	00201050	POULIE MOTRICE
15	1	00204455	COURROIE
16	1	000004A7	PLAQUE LIAISON BOITE MOTEUR D
17	1	00204207	SUPPORT BOITE AR
18	1	00201511	PATTE SUPPORT CABLE SELECTEUR
19	1	00201472	BOITE INVERSEUR 1/10
20	1	00201405	PATTE SELECTEUR
21	1	00202509	POULIE RECEPTRICE
22	1	000004A8	PLAQUE LIAISON BOITE MOTEUR G
23	1	00652013	SERRE-CABLE ACCELERATEUR
24	1	00202822	TRANSMISSION AR D & ROUE
25	1	00202816	TRANSMISSION AR G

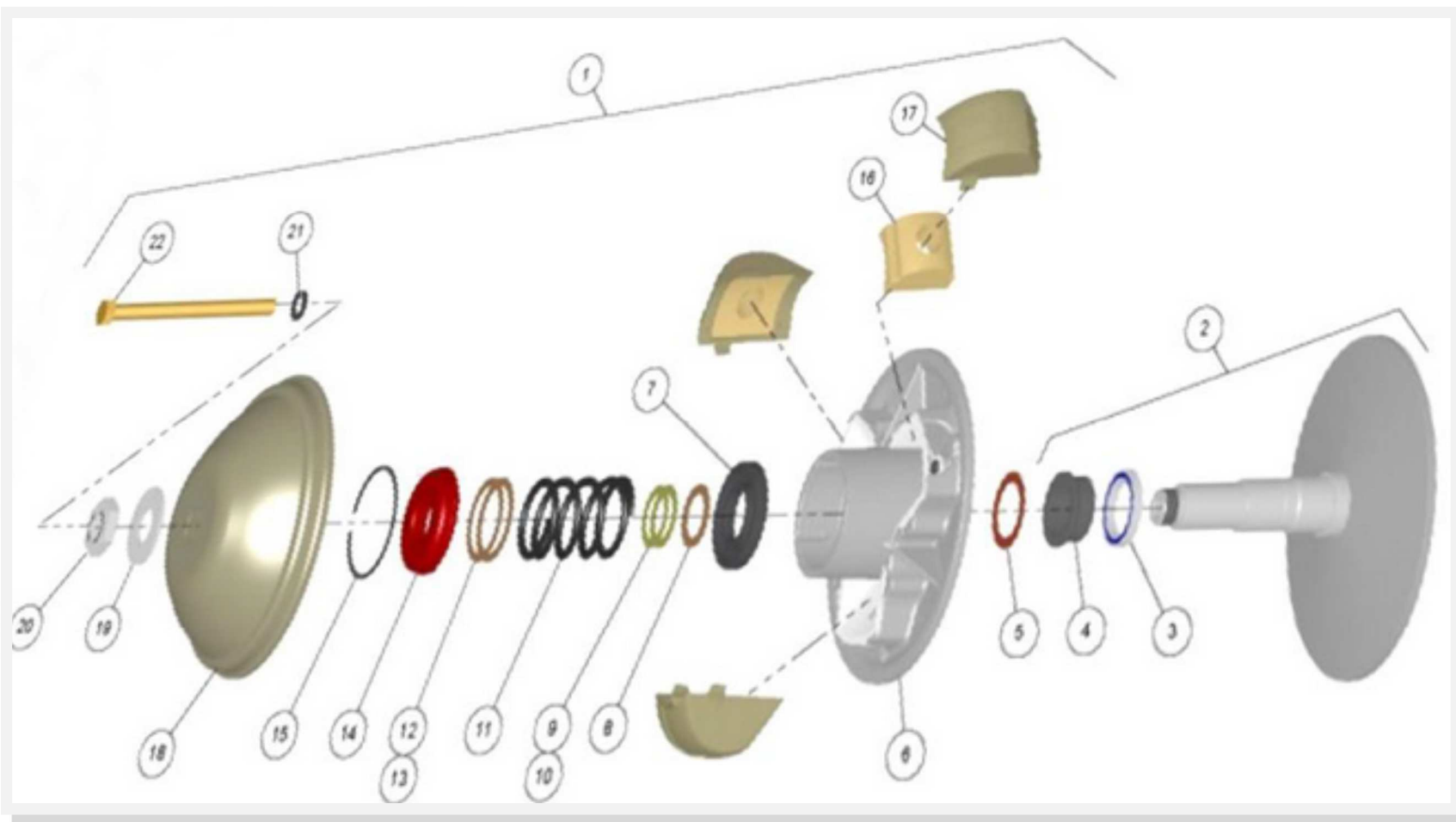

Repère	Q.TE	Référence	Désignation
1	1	00201053	POULIE MOTRICE
2			FLASQUE FIXE
3	1	00201038	ROULEMENT DEBRAYAGE MOTRICE
4			BAGUE DE SERRAGE
5			RONDELLE D ESPACEMENT
6	1	00201031	FLASQUE COULISSANT
7	1	00201041	COUSSINET INF
8			RONDELLE D ESPACEMENT
9			RONDELLE D ESPACEMENT
10			RONDELLE D ESPACEMENT
11	1	00202551	RESSORT
12	1	00202533	CALE COURROIE ASA1
13	1	00201003	CALE COURROIE ASA1S
14	1	00201040	COUSSINET SUPERIEUR
15	1	00201030	SEGMENT D ARRET C15
16	1	00202552	MASSELOTTE
17			BLOC CENTRIFUGE
18			CAPUCHON
19			RONDELLE
20			ECROU DE BLOCAGE
21			RONDELLE DE FIXATION
22			BOULON DE FIXATION

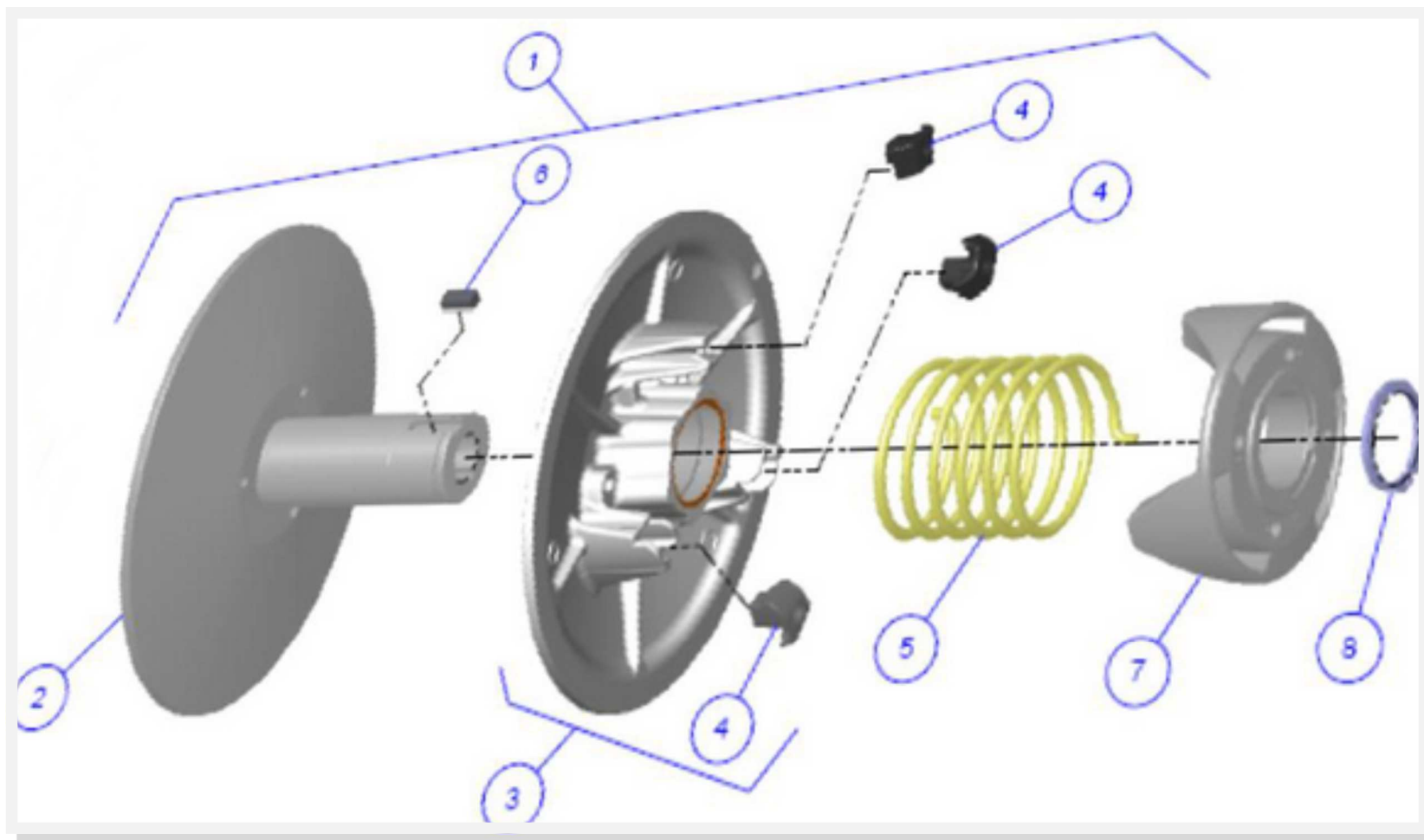

<b>Repère</b>	<b>Q.TE</b>	<b>Référence</b>	<b>Désignation</b>
1	1	00202510	POULIE RECEPTRICE
2			FLASQUE FIXE
3			FLASQUE COULISSANT
4	3	00202544	PATIN DE CAME
5	1	00202516	RESSORT POULIE RECEP DOCKER
6			CLAVETTE
7			CAME
8	1	00202533	SEGMENT D ARRET EXT COURROIE

	<b>140</b>	<b>POULIE RECEPTRICE</b>	<b>DOCKER</b>
---	------------	--------------------------	---------------

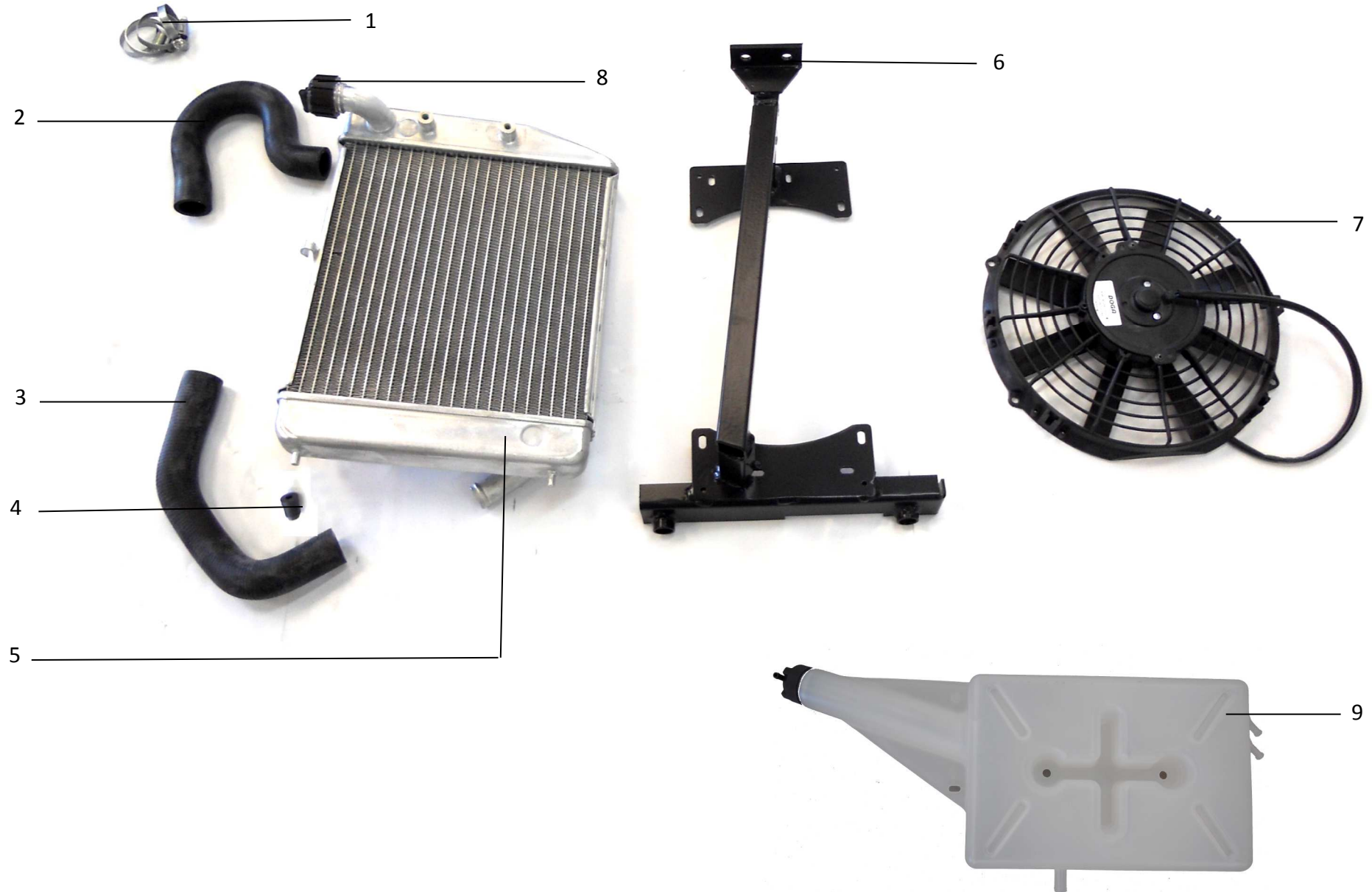

<b>Repère</b>	<b>Q.TE</b>	<b>Référence</b>	<b>Désignation</b>
1	4	000004B2	COLLIER 25X40
2	1	00004605	DURITE SUP EAU
3	1	00004621	DURITE INF EAU RADIATEUR ALU
4	2	00981702	SILENTBLOC RADIATEUR ALU
5	1	00001702	RADIATEUR ALU
6	1	00001719	SUPPORT RADIATEUR ALU
7	1	00450876	VENTILATEUR REFROIDISSEMENT
8	1	00001723	BOUCHON RADIATEUR
9	1	01051705	VASE EXPANSION

	<b>150</b>	<b>SYSTÈME DE REFROIDISSEMENT</b>	<b>DOCKER</b>
---	------------	-----------------------------------	---------------

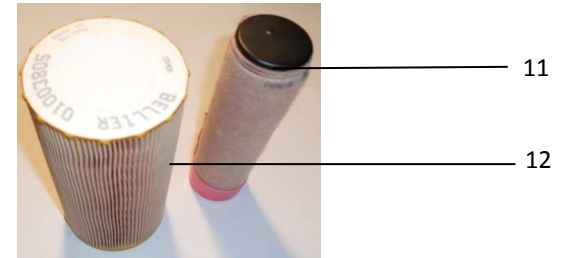
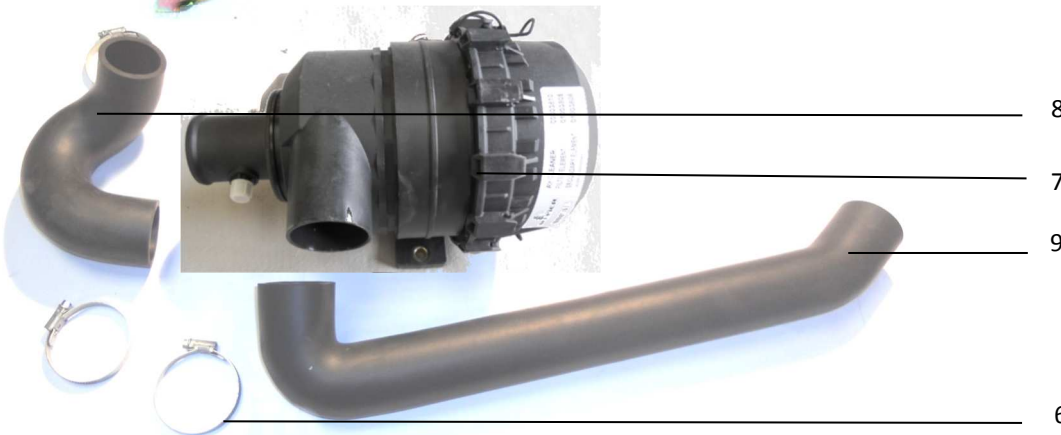
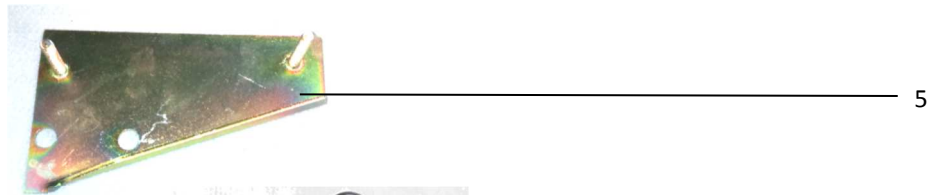
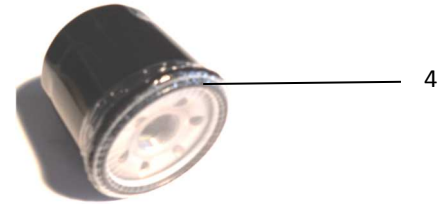
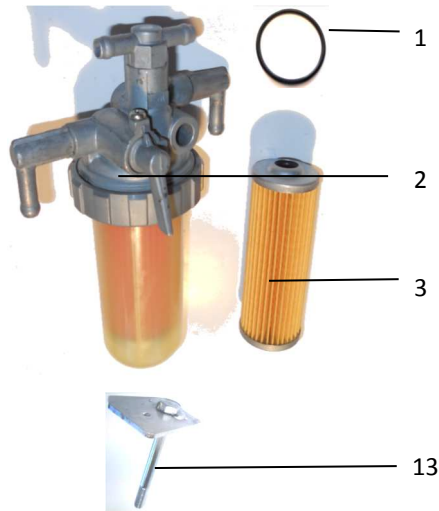



Repère	Q.TE	Référence	Désignation
1	1	00000411	JOINT TORIQUE
2	1	00003805	SUPPORT ET FILTRE GO COMPLET
3	1	00003802	FILTRE GO YAN
4	1	00003803	FILTRE A HUILE YAN
5	1	000004B0	SUPPORT FILTRE AIR
6	3	000004A5	COLLIER 50/60
7	1	00003810	BOITIER FILTRE A AIR
8	1	00004601	DURITE FILTRE A AIR COUDEE
9	1	00004615	DURITE ASPIRATION FILTRE A AIR
11	1	01003806	CARTOUCHE SECONDAIRE FILTRE
12	1	01003805	CARTOUCHE PRINCIPALE
13	1	02004205	SUPPORT FILTRE GO

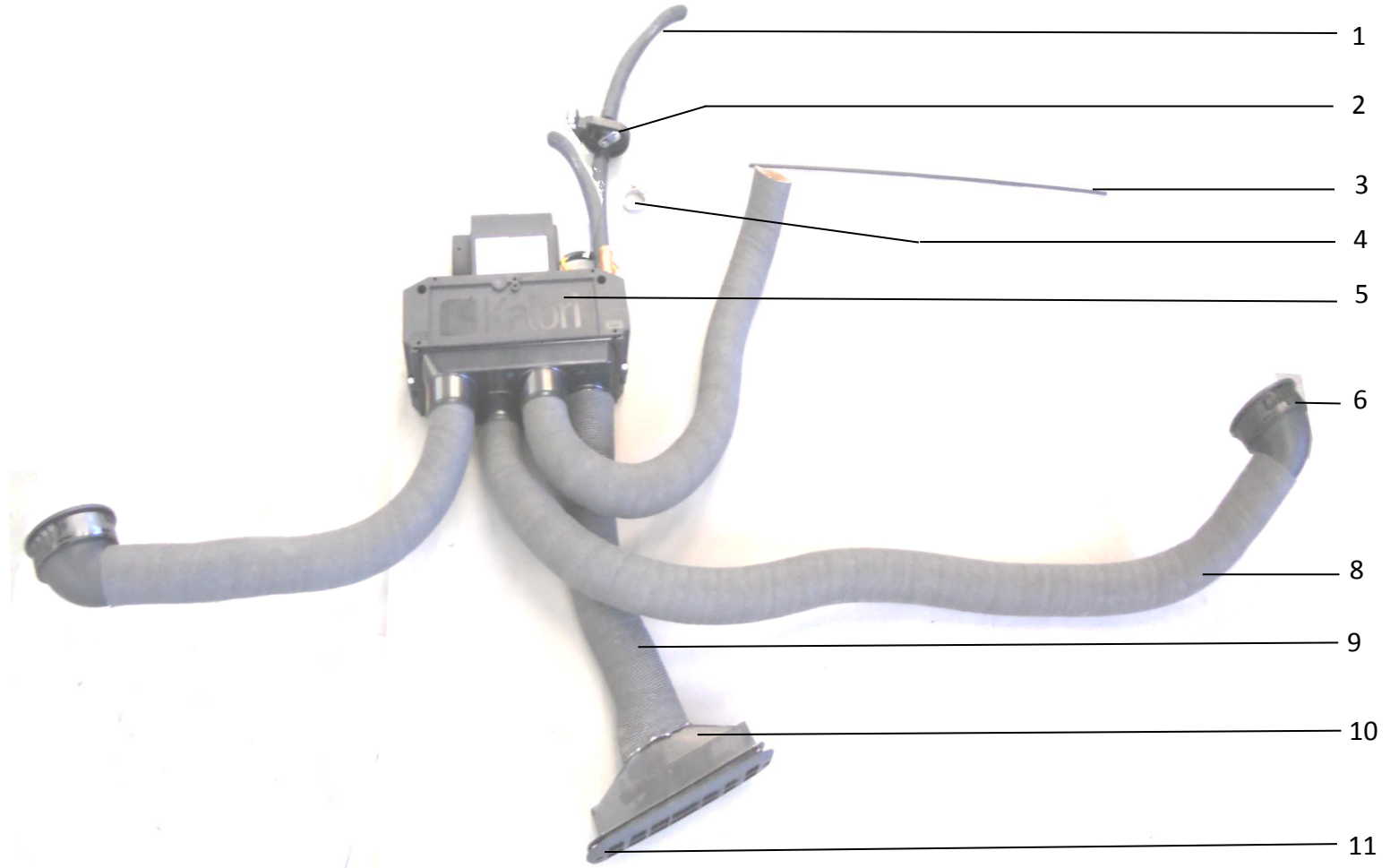
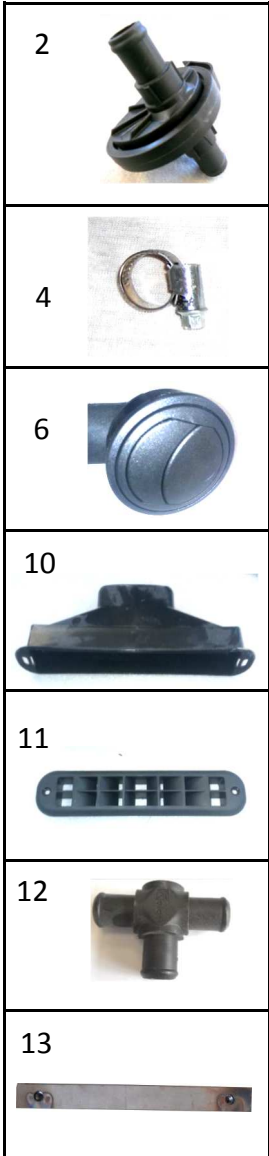

Repère	Q.TE	Référence	Désignation
1	2	00004619	DURITE D16MM EAU CHAUFFAGE
2	1	00501617	ROBINET DE CHAUFFAGE
3	1	00651607	CABLE COMMANDE CHAUFFAGE
4	10	000004B1	COLLIER 16X27
5	1	00451617	CHAUFFAGE COMPACT
6	2	00501606	BOUCHE CHAUFFAGE KB NOIRE
8	3	00504603	GAINÉ CHAUFFAGE PAP45—650mm—460mm—1080mm
9	1	01501616	GAINÉ CHAUFFAGE PAP55—340mm
10	2	00451616	QUEUE CARPE CHAUFFAGE
11	2	00501618	GRILLE DESEMBUAGE
12	1	00001720	RACCORD EN T
13	1	00501619	SUPPORT CHAUFFAGE



1

2

4

11

3

8

5

6

10

7

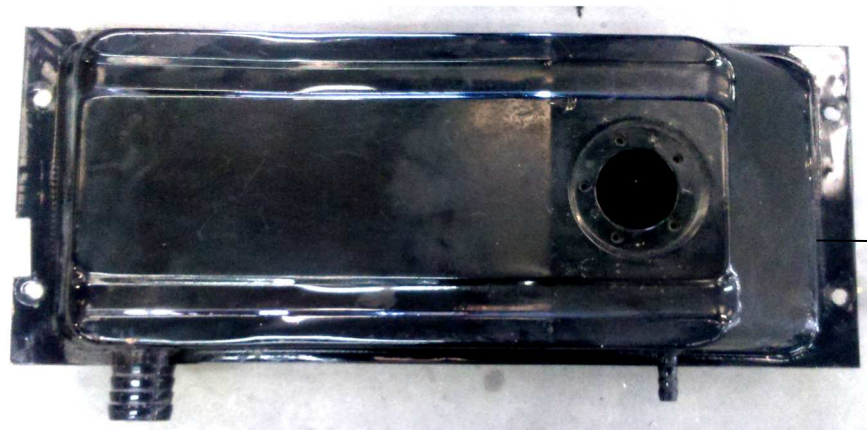

12

**DIESEL**

9



13

Repère	Q.TE	Référence	Désignation
1	1	A1354600	GOULOTTE REMPLISSAGE GO
2	1	----	DURITE AU M L: 740mm
3	1	----	DURITE AU M L : 650mm
4	1	00354605	DURITE GO AU M L: 500mm / 240mm / 180mm
5	1	02355000	RESERVOIR GO
6	2	00354201	PATTE SUPPORT RESERVOIR GO
7	1	A1350100	BOUCHON ANTIVOL RESERVOIR
8	2	00354606	TUYAU GO MANURIL 6 X 8
9	1	00102915	AUTOCOLLANT « DIESEL
10	1	02350800	JAUGE RESERVOIR
11	1	00053803	PREFILTRE
12	1	----	ANCIEN RESERVOIR REMPLACE PAR 02355000)
13	1	----	ANCIENNE JAUGE REMPLACE PAR 02350800)